



**CORECO**



# MESAS REFRIGERADAS REFRIGERATED COUNTERS

## 600 (snack)



**Pag. 22-25**

Mesa fría SNACK  
*SNACK refrigerated counter*



**Pag. 26-31**

Mesa fría SNACK frente mostrador  
*Back bar SNACK counter*



**Pag. 32-37**

Muebles neutros  
*Neutral complements*



## 700 (GN 1/1)

**Pag. 38-39**



Mesa fría GN1/1 bajo-mostrador ALTA EFICIENCIA  
*HIGH EFFICIENCY GN 1/1 counter*



**Pag. 40-43**

Mesa fría GN1/1 bajo-mostrador  
*GN 1/1 counter*



**Pag. 44-45**

Mesa fría GN1/1 central  
*pass through GN 1/1 counter*

**Pag. 46-47**

Mesa fría GN1/1 compacta  
*Compact GN 1/1 counter*

**Pag. 48-53**

Mesa fría GN bajo-cocina  
*Under broiler GN counter*



## 800 (60x40)

**Pag. 54-55**

Mesa fría 60x40 bajo-mostrador  
*60x40 counter*

## CARACTERISTICAS GENERALES GENERAL FEATURES

### 600 (snack)



### 700 (GN 1/1)



### 800 (60x40)



REFRIGERATED COUNTERS • MESAS REFRIGERADAS

- Exterior en acero inox AISI-304, excepto el respaldo
- Interior en acero inox AISI-304
- Puertas de apertura reversible, con sistema de cierre automático y burlete magnético (permanece abierta al superar los 90° de apertura)
- Contrapuerta inox embutida
- Encimera con frente curvo y peto trasero sanitario de 100 mm (según modelo puede variar)
- Estantes interiores de alambre en acero plastificado, regulables en altura (según modelo puede variar)
- Pies en acero inox (160 mm) ajustables en altura
- Unidad condensadora ventilada y extraíble en el lado derecho
- Evaporador en la parte superior, con tratamiento anticorrosión
- Evaporación automática del agua de descarche

- AISI-304 stainless steel exterior, rear side galvanized panel
- AISI-304 stainless steel interior
- Doors with self closing system, blocked opening, magnetic gasket and possibility of changing the opening sense
- Worktop with rounded front and 100 mm sanitary upstand (depending on model, can change)
- Plasticized steel wire shelves, height adjustable (depending on model, can change)
- Stainless steel adjustable legs
- Right side removable and fan assisted condenser unit
- Evaporator on the upper internal side, coated with anti-corrosion material
- Automatic evaporation of defrost water

### AISI-304



patas de 160 mm  
160 mm leg



bisagras cierre automático  
self closing hinges

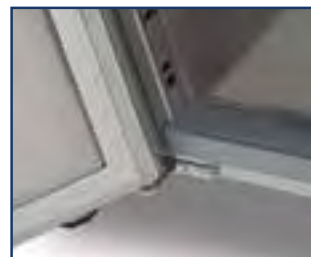

unidad cond. extraíble  
removable cond. unit



interior esquinas redondeadas  
rounded corner edges



burlete desmontable  
gasket detachable



contrapuerta embutida  
pressformed rear door



evaporador en el techo  
top mounted evaporator

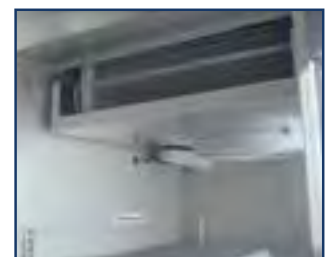

desagüe limpieza  
cleaning drainage

all photos must be considered as a reference - fotografías no contractuales

## OPCIONES BAJO PEDIDO OPTIONS ON DEMAND

sin peto  
no splash-back



fregadero  
sink



encimera de granito  
granite worktop



patas de 90 mm  
90 mm legs



ruedas  
castors



pre-instalación  
remote condenser unit



puerta con cerradura  
lock for door



cajones (autocierre)  
drawers (selfclosing)



puertas de cristal  
glass doors



cajones frente de cristal  
drawers with front glass



motor lado izquierdo  
left side condenser unit



respaldo inox  
SS rear side



estantes chapa perforada  
perforated shelves

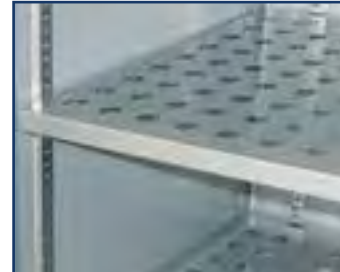

hidrocarburo  
hydrocarbon



voltaje y frecuencia  
voltage and frequency

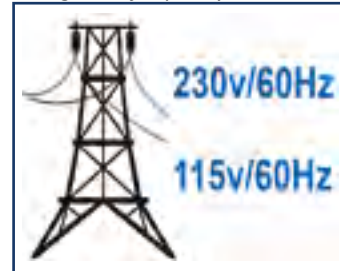





|          |         |
|----------|---------|
| MRS-150  | 1.762 € |
| MRSF-150 | 1.991 € |
| MCS-150  | 2.223 € |

|          |         |
|----------|---------|
| MRS-200  | 2.089 € |
| MRSF-200 | 2.306 € |
| MCS-200  | 2.580 € |

|          |         |
|----------|---------|
| MRS-250  | 2.471 € |
| MRSF-250 | 2.709 € |

|          |         |
|----------|---------|
| MRS-300  | 2.957 € |
| MRSF-300 | 3.267 € |

| mod.    | rango range °C | largo length (mm) | alto height (mm) | fondo depth (mm) | estantes shelves | volumen capacity (L) | voltaje voltage | refrigerante refrigerant | potencia frig. frig. power W | potencia power W | CCE EEC 2015/1094 EN16825 |
|---------|----------------|-------------------|------------------|------------------|------------------|----------------------|-----------------|--------------------------|------------------------------|------------------|---------------------------|
| MRS-150 | -2°C +8°C      | 1495              | 850              | 600              | 2                | 245                  | 230V-50Hz       | R134a                    | 178                          | 211              | C                         |
|         |                |                   |                  |                  |                  |                      |                 | R290*                    | 280                          | 218              | B                         |
| MRS-200 | -2°C +8°C      | 2020              | 850              | 600              | 3                | 380                  | 230V-50Hz       | R134a                    | 245                          | 249              | D                         |
|         |                |                   |                  |                  |                  |                      |                 | R290*                    | 280                          | 220              | B                         |
| MRS-250 | -2°C +8°C      | 2545              | 850              | 600              | 4                | 516                  | 230V-50Hz       | R134a                    | 304                          | 289              | C                         |
|         |                |                   |                  |                  |                  |                      |                 | R290*                    | 739                          | 412              | C                         |
| MRS-300 | -2°C +8°C      | 3070              | 850              | 600              | 5                | 651                  | 230V-50Hz       | R134a                    | 356                          | 304              | D                         |
|         |                |                   |                  |                  |                  |                      |                 | R290*                    | 739                          | 416              | C                         |
| MCS-150 | -20°C -15°C    | 1495              | 850              | 600              | 2                | 245                  | 230V-50Hz       | R290                     | 606                          | 535              | E                         |
|         |                |                   |                  |                  |                  |                      |                 | R452A*                   | 353                          | 556              | F                         |
| MCS-200 | -20°C -15°C    | 2020              | 850              | 600              | 3                | 380                  | 230V-50Hz       | R290                     | 606                          | 556              | E                         |
|         |                |                   |                  |                  |                  |                      |                 | R452A*                   | 452                          | 610              | F                         |

\*opcional - optional

Características técnicas y constructivas sujetas a variación sin previo aviso.

We reserve the right to change specifications without prior notice.

- Exterior en acero inox AISI-304, excepto el respaldo
- Interior en acero inox AISI-304, con aristas curvas y fondo embutido
- Puertas de apertura reversible, con sistema de cierre automático y burlete magnético (permanece abierta al superar los 90° de apertura)
- Contrapuerta inox embutida
- Encimera de acero inox AISI-304 con frente curvo y peto trasero sanitario de 100 mm (opcional sin peto)
- Estantes interiores de alambre en acero plastificado, regulables en altura, sobre apoyos inox
- Pies en tubo de acero inox ajustables en altura 125 - 200 mm
- Unidad condensadora ventilada y extraíble
- Evaporador sistema tiro forzado, con recubrimiento epoxi anticorrosión
- Evaporación automática del agua de descarche
- Aislamiento de poliuretano inyectado, densidad 40 Kg/m<sup>3</sup>, cero efectos ODP y GWP
- Control digital de temperatura, descarches optimizados, alarma por alta temperatura de condensación. Eficiente gestión del consumo de energía
- Temperatura de trabajo: 38°C ambiente

- AISI-304 stainless steel exterior, rear side galvanized panel
- AISI-304 stainless steel interior, stamped bottom and rounded corners
- Doors with self closing system, blocked opening, magnetic gasket and possibility of changing the opening sense
- Inner side of doors by stamped steel
- AISI-304 stainless steel worktop, with rounded front and 100 mm sanitary upstand (optional without upstand)
- Shelves made of plasticized steel wire, height adjustable by stainless steel supports
- AISI -304 adjustable legs, 125 to 200 mm
- Removable and fan assisted condenser unit
- Fan assisted evaporator, with epoxi anticorrosion coating.
- Automatic evaporation of defrost water
- 40 Kg/m<sup>3</sup> density polyurethane insulation, zero ODP and GWP
- Digital temperature control, optimized defrost, high-temperature condensation alarm. Efficient management of energy consumption
- Operating temperature: 38°C ambient

REFRIGERATED COUNTERS • MESAS REFRIGERADAS

|  |   |  |       |
|--|---|--|-------|
|  | Incremento precio por cambio de puerta a cajonera <b>doble</b> refrigerada inox desmontable sobre guías inox telescópicas, sistema auto-cierre  | Increase of price by changing door to <b>double</b> drawers set, detachable telescopic SS runners, soft-closing system | 363 € |
|  | Incremento precio por cambio de puerta a cajonera <b>triple</b> refrigerada inox desmontable sobre guías inox telescópicas, sistema auto-cierre | Increase of price by changing door to <b>triple</b> drawers set, detachable telescopic SS runners, soft-closing system | 537 € |

| OPCIONES                          | OPTIONS                          | €                   |
|-----------------------------------|----------------------------------|---------------------|
| parrilla adicional                | extra shelf                      | 20 €                |
| cambio R134a por R290             | R134a to R290                    | + 5 %               |
| cambio R290 por R452A             | R290 to R452A                    | 0 %                 |
| cajonera doble inox, auto-cierre  | double drawers set, soft-closing | 363 € x set         |
| cajonera triple inox, auto-cierre | triple drawers set, soft-closing | 537 € x set         |
| cerradura puerta inox             | solid door lock                  | 15 € x ud           |
| motor lado izquierdo              | left side engine                 | 56 €                |
| motor lado izquierdo + fregadero  | left side engine + sink          | 414 €               |
| encimera sin peto                 | no upstand worktop               | 0 €                 |
| set 4 ruedas                      | 4 castors set                    | 76 € x set          |
| set 6 ruedas                      | 6 castors set                    | 117 € x set         |
| registrador de alarmas HACCP      | HACCP alarm recorder             | 250 € x set         |
| tropicalizado 43°C                | tropicalized to 43°C             | consultar - consult |
| 230v 60Hz / 115v 60Hz             | 230v 60Hz / 115v 60Hz            | consultar - consult |
| pre-instalación                   | remote compressor                | consultar - consult |
| respaldo inox                     | stainless steel rear side        | consultar - consult |

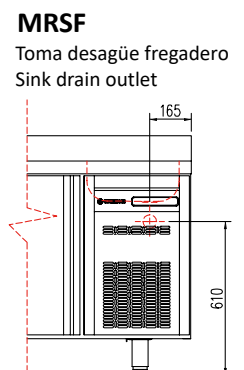
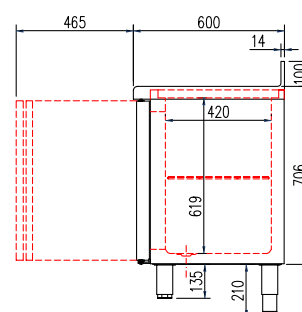

all photos must be considered as a reference - fotografías no contractuales



MRS-200



MRS-200  
con cajones auto-cierre  
with soft-closing drawers

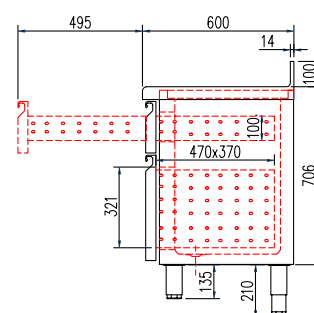
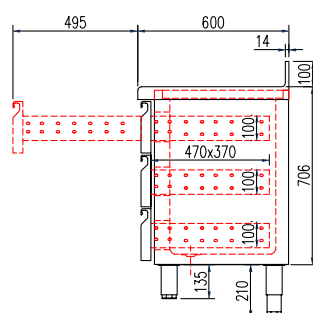
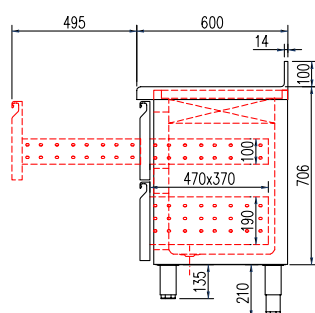
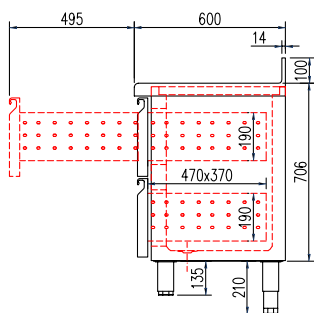

Pre-instalación opcional  
Optional remote compressor

Fregadero 340 x 360 x 160  
340 x 360 x 160 Sink





|          |         |
|----------|---------|
| MRSV-150 | 2.065 € |
| MCSV-150 | 2.523 € |

|          |         |
|----------|---------|
| MRSV-200 | 2.497 € |
| MCSV-200 | 3.024 € |

|          |         |
|----------|---------|
| MRSV-250 | 2.997 € |
| MCSV-250 | 3.642 € |

|          |         |
|----------|---------|
| MRSV-300 | 3.572 € |
|----------|---------|

| mod.     | rango range °C | largo length (mm) | alto height (mm) | fondo depth (mm) | estantes shelves | volumen capacity (L) | voltaje voltage | refrigerante refrigerant | potencia frig. frig. power | potencia power W |
|----------|----------------|-------------------|------------------|------------------|------------------|----------------------|-----------------|--------------------------|----------------------------|------------------|
| MRSV-150 | -2°C +8°C      | 1495              | 850              | 600              | 2                | 245                  | 230V-50Hz       | R134a                    | 245                        | 262              |
|          |                |                   |                  |                  |                  |                      |                 | R290*                    | 280                        | 221              |
| MRSV-200 | -2°C +8°C      | 2020              | 850              | 600              | 3                | 380                  | 230V-50Hz       | R134a                    | 304                        | 306              |
|          |                |                   |                  |                  |                  |                      |                 | R290*                    | 502                        | 246              |
| MRSV-250 | -2°C +8°C      | 2545              | 850              | 600              | 4                | 516                  | 230V-50Hz       | R134a                    | 485                        | 447              |
|          |                |                   |                  |                  |                  |                      |                 | R290*                    | 739                        | 422              |
| MRSV-300 | -2°C +8°C      | 3070              | 850              | 600              | 5                | 651                  | 230V-50Hz       | R134a                    | 485                        | 451              |
|          |                |                   |                  |                  |                  |                      |                 | R290*                    | 739                        | 430              |
| MCSV-150 | -20°C -15°C    | 1495              | 850              | 600              | 2                | 245                  | 230V-50Hz       | R290                     | 606                        | 544              |
|          |                |                   |                  |                  |                  |                      |                 | R452A*                   | 353                        | 565              |
| MCSV-200 | -20°C -15°C    | 2020              | 850              | 600              | 3                | 380                  | 230V-50Hz       | R290                     | 606                        | 548              |
|          |                |                   |                  |                  |                  |                      |                 | R452A*                   | 452                        | 623              |

\*opcional - optional

Características técnicas y constructivas sujetas a variación sin previo aviso.

We reserve the right to change specifications without prior notice.

- Exterior en acero inox AISI-304, excepto el respaldo
- Interior en acero inox AISI-304, con aristas curvas y fondo embutido
- Puertas de apertura reversible, con sistema de cierre automático y burlete magnético (permanece abierta al superar los 90° de apertura)
- Doble cristal + LEDs
- Encimera de acero inox AISI-304 con frente curvo y peto trasero sanitario de 100 mm (opcional sin peto)
- Estantes interiores de alambre en acero plastificado, regulables en altura, sobre apoyos inox
- Pies en tubo de acero inox ajustables en altura 125 - 200 mm
- Unidad condensadora ventilada y extraíble
- Evaporador sistema tiro forzado, con recubrimiento epoxi anticorrosión
- Evaporación automática del agua de descarche
- Aislamiento de poliuretano inyectado, densidad 40 Kg/m<sup>3</sup>, cero efectos ODP y GWP
- Control digital de temperatura, descarches optimizados, alarma por alta temperatura de condensación. Eficiente gestión del consumo de energía
- Temperatura de trabajo: 32°C ambiente

- AISI-304 stainless steel exterior, rear side galvanized panel
- AISI-304 stainless steel interior, stamped bottom and rounded corners
- Doors with self closing system, blocked opening, magnetic gasket and possibility of changing the opening sense
- Double glazed doors + LEDs
- AISI-304 stainless steel worktop, with rounded front and 100 mm sanitary upstand (optional without upstand)
- Shelves made of plasticized steel wire, height adjustable by stainless steel supports
- AISI-304 adjustable legs, 125 to 200 mm
- Removable and fan assisted condenser unit
- Fan assisted evaporator, with epoxi anticorrosion coating.
- Automatic evaporation of defrost water
- 40 Kg/m<sup>3</sup> density polyurethane insulation, zero ODP and GWP
- Digital temperature control, optimized defrost, high-temperature condensation alarm. Efficient management of energy consumption
- Operating temperature: 32°C ambient

| OPCIONES                     | OPTIONS                   | €                   |
|------------------------------|---------------------------|---------------------|
| parrilla adicional           | extra shelf               | 20 €                |
| cambio R134a por R290        | R134a to R290             | + 5 %               |
| cambio R290 por R452A        | R290 to R452A             | 0 %                 |
| cerradura puerta cristal     | glass door lock           | 46 € x ud           |
| motor lado izquierdo         | left side engine          | 56 €                |
| encimera sin peto            | no upstand worktop        | 0 €                 |
| set 4 ruedas                 | 4 castors set             | 76 € x set          |
| set 6 ruedas                 | 6 castors set             | 117 € x set         |
| registrador de alarmas HACCP | HACCP alarm recorder      | 250 € x set         |
| tropicalizado 43°C           | tropicalized to 43°C      | consultar - consult |
| 230v 60Hz / 115v 60Hz        | 230v 60Hz / 115v 60Hz     | consultar - consult |
| pre-instalación              | remote compressor         | consultar - consult |
| respaldo inox                | stainless steel rear side | consultar - consult |

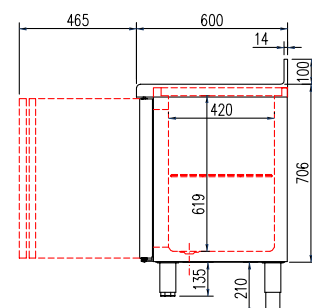

# Mesa fría SNACK, refrigeración y congelados SNACK chiller and freezer counter

1

all photos must be considered as a reference - fotografías no contractuales



MRSV-200

Pre-instalación opcional  
Optional remote compressor







FMR-150 1.980 €



FMR-200 2.384 €



FMR-250 2.776 €



FMR-300 3.206 €

| mod.    | rango range °C | largo length (mm) | alto height (mm) | fondo depth (mm) | estantes shelves | volumen capacity (L) | voltaje voltage | refrigerante refrigerant | potencia frig. frig. power W | potencia power W | CCE EEC 2015/1094 EN16825 |
|---------|----------------|-------------------|------------------|------------------|------------------|----------------------|-----------------|--------------------------|------------------------------|------------------|---------------------------|
| FMR-150 | -2°C +8°C      | 1495              | 1040             | 600              | 4                | 325                  | 230V-50Hz       | R134a                    | 178                          | 211              | C                         |
|         |                |                   |                  |                  |                  |                      |                 | R290*                    | 280                          | 218              | B                         |
| FMR-200 | -2°C +8°C      | 2020              | 1040             | 600              | 6                | 504                  | 230V-50Hz       | R134a                    | 245                          | 249              | C                         |
|         |                |                   |                  |                  |                  |                      |                 | R290*                    | 280                          | 220              | B                         |
| FMR-250 | -2°C +8°C      | 2545              | 1040             | 600              | 8                | 684                  | 230V-50Hz       | R134a                    | 304                          | 289              | C                         |
|         |                |                   |                  |                  |                  |                      |                 | R290*                    | 739                          | 412              | C                         |
| FMR-300 | -2°C +8°C      | 3070              | 1040             | 600              | 10               | 863                  | 230V-50Hz       | R134a                    | 356                          | 304              | C                         |
|         |                |                   |                  |                  |                  |                      |                 | R290*                    | 739                          | 416              | C                         |

\*opcional - optional

Características técnicas y constructivas sujetas a variación sin previo aviso.

We reserve the right to change specifications without prior notice.

REFRIGERATED COUNTERS • MESAS REFRIGERADAS

- Exterior en acero inox AISI-304, excepto el respaldo
- Interior en acero inox AISI-304, con aristas curvas y fondo embutido
- Puertas de apertura reversible, con sistema de cierre automático y burlete magnético (permanece abierta al superar los 90° de apertura)
- Contrapuerta inox embutida
- De serie, dotación de dos cajones neutros, opcional cajón tolva.
- Unidad condensadora ventilada y extraíble
- Evaporación automática del agua de descarche
- Encimera de acero inox AISI-304 con frente curvo y peto trasero sanitario de 100 mm (opcional sin peto)
- Estantes interiores de alambre en acero plastificado, regulables en altura, sobre apoyos inox
- Pies en tubo de acero inox ajustables en altura 125 - 200 mm
- Evaporador sistema tiro forzado, con recubrimiento epoxi anticorrosión
- Aislamiento de poliuretano inyectado, densidad 40 Kg/m<sup>3</sup>, cero efectos ODP y GWP
- Control digital de temperatura, descarches optimizados, alarma por alta temperatura de condensación (FMR). Eficiente gestión del consumo de energía
- Temperatura de trabajo a 38°C ambiente

- AISI-304 stainless steel exterior, rear side galvanized panel
- AISI-304 stainless steel interior, stamped bottom and rounded corners
- Doors with self closing system, blocked opening, magnetic gasket and possibility of changing the opening sense
- Inner side of doors by stamped steel
- Standard, two drawers, coffee-grounds hopper optional
- Removable and fan assisted condenser unit
- Automatic evaporation of defrost water
- AISI-304 stainless steel worktop, with rounded front and 100 mm sanitary upstand (optional without upstand)
- Shelves made of plasticized steel wire, height adjustable by stainless steel supports
- AISI-304 adjustable legs, 125 to 200 mm
- Fan assisted evaporator, with epoxi anticorrosion coating.
- 40 Kg/m<sup>3</sup> density polyurethane insulation, zero ODP and GWP
- Digital temperature control, optimized defrost, high-temperature condensation alarm (FMR). Efficient management of energy consumption
- Operating temperature, 38°C ambient

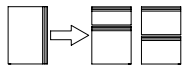
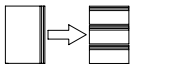
|   |   |   |       |
|---|---|---|-------|
|  | Incremento precio por cambio de puerta a cajonera <b>doble</b> refrigerada inox desmontable sobre guías inox telescópicas, sistema auto-cierre  | <i>Increase of price by changing door to <b>double</b> drawers set, detachable telescopic SS runners, soft-closing system</i> | 570 € |
|  | Incremento precio por cambio de puerta a cajonera <b>triple</b> refrigerada inox desmontable sobre guías inox telescópicas, sistema auto-cierre | <i>Increase of price by changing door to <b>triple</b> drawers set, detachable telescopic SS runners, soft-closing system</i> | 715 € |

| OPCIONES                            | OPTIONS                                  | €                   |
|-------------------------------------|--|---------------------|
| parrilla adicional                  | extra shelf                              | 20 €                |
| cambio R134a por R290               | R134a to R290                            | + 5 %               |
| cámbio cajón tolva café por cajones | coffee-grounds hopper instead of drawers | 363 € x set         |
| cajonera doble inox, auto-cierre    | double drawers set, soft-closing         | 363 € x set         |
| cajonera triple inox, auto-cierre   | triple drawers set, soft-closing         | 537 € x set         |
| cerradura puerta inox               | solid door lock                          | 15 € x ud           |
| motor lado izquierdo                | left side engine                         | 56 €                |
| encimera sin peto                   | no upstand worktop                       | 0 €                 |
| set 4 ruedas                        | 4 castors set                            | 76 € x set          |
| set 6 ruedas                        | 6 castors set                            | 117 € x set         |
| registrador de alarmas HACCP        | HACCP alarm recorder                     | 250 € x set         |
| tropicalizado 43°C                  | tropicalized to 43°C                     | consultar - consult |
| 230v 60Hz / 115v 60Hz               | 230v 60Hz / 115v 60Hz                    | consultar - consult |
| respaldo inox                       | stainless steel rear side                | consultar - consult |

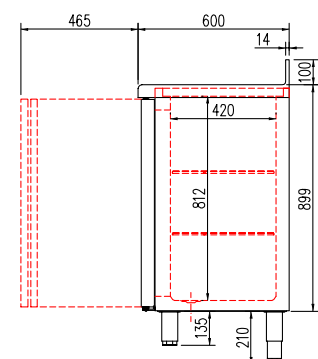

all photos must be considered as a reference - fotografías no contractuales



FMR-250



FMR-250  
con cajones auto-cierre  
with soft-closing drawers

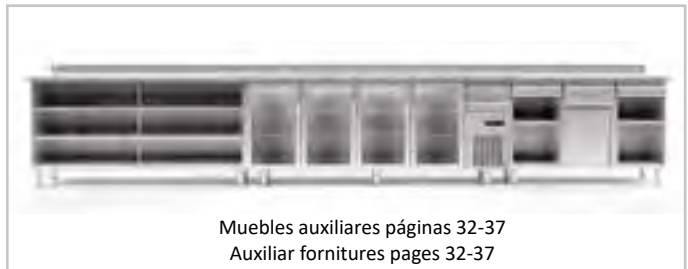
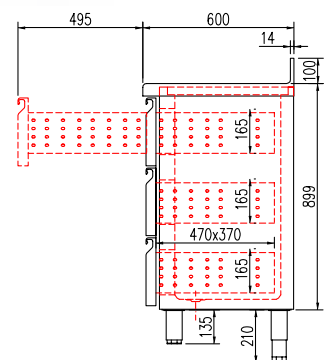
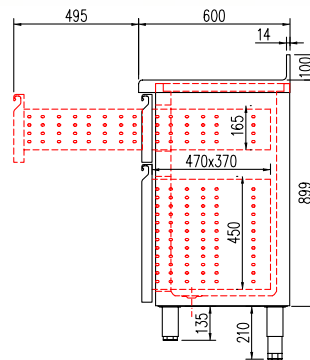
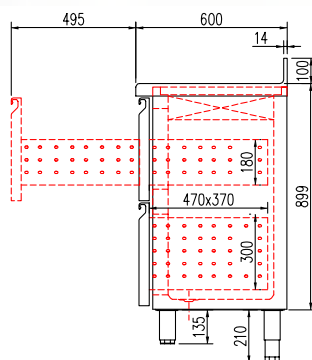
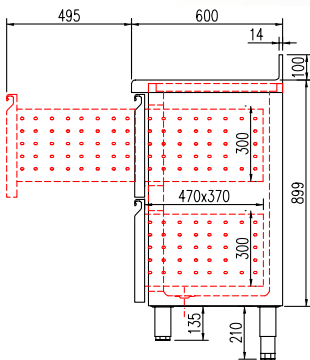

Muebles auxiliares páginas 32-37  
Auxiliar furnishings pages 32-37



FMRV-150 2.321 €



FMRV-200 2.843 €



FMRV-250 3.386 €



FMRV-300 3.919 €

| mod.     | rango range °C | largo length (mm) | alto height (mm) | fondo depth (mm) | estantes shelves | volumen capacity (L) | voltaje voltage | refrigerante refrigerant | potencia frig. frig. power W | potencia power W |
|----------|----------------|-------------------|------------------|------------------|------------------|----------------------|-----------------|--------------------------|------------------------------|------------------|
| FMRV-150 | -2°C +8°C      | 1495              | 1040             | 600              | 4                | 325                  | 230V-50Hz       | R134a                    | 245                          | 262              |
|          |                |                   |                  |                  |                  |                      |                 | R290*                    | 280                          | 225              |
| FMRV-200 | -2°C +8°C      | 2020              | 1040             | 600              | 6                | 504                  | 230V-50Hz       | R134a                    | 304                          | 306              |
|          |                |                   |                  |                  |                  |                      |                 | R290*                    | 502                          | 250              |
| FMRV-250 | -2°C +8°C      | 2545              | 1040             | 600              | 8                | 684                  | 230V-50Hz       | R134a                    | 485                          | 447              |
|          |                |                   |                  |                  |                  |                      |                 | R290*                    | 739                          | 426              |
| FMRV-300 | -2°C +8°C      | 3070              | 1040             | 600              | 10               | 863                  | 230V-50Hz       | R134a                    | 485                          | 451              |
|          |                |                   |                  |                  |                  |                      |                 | R290*                    | 739                          | 445              |

\*opcional - optional

Características técnicas y constructivas sujetas a variación sin previo aviso.

- Exterior en acero inox AISI-304, excepto el respaldo
- Interior en acero inox AISI-304, con aristas curvas y fondo embutido
- Puertas de apertura reversible, con sistema de cierre automático y burlete magnético (permanece abierta al superar los 90° de apertura)
- Doble cristal
- Luz interior estándar por LEDs
- De serie, dotación de dos cajones neutros, opcional cajón tolva.
- Unidad condensadora ventilada y extraíble
- Evaporación automática del agua de descarche
- Encimera de acero inox AISI-304 con frente curvo y peto trasero sanitario de 100 mm (opcional sin peto)
- Estantes interiores de alambre en acero plastificado, regulables en altura, sobre apoyos inox
- Pies en tubo de acero inox ajustables en altura 125 - 200 mm
- Evaporador sistema tiro forzado, con recubrimiento epoxi anticorrosión
- Aislamiento de poliuretano inyectado, densidad 40 Kg/m<sup>3</sup>, cero efectos ODP y GWP
- Control digital de temperatura, descarches optimizados, alarma por alta temperatura de condensación (FMRV). Eficiente gestión del consumo de energía
- Temperatura de trabajo a 32°C ambiente

We reserve the right to change specifications without prior notice.

- AISI-304 stainless steel exterior, rear side galvanized panel
- AISI-304 stainless steel interior, stamped bottom and rounded corners
- Doors with self closing system, blocked opening, magnetic gasket and possibility of changing the opening sense
- Double glazed door
- Interior LEDs lighting as standard
- Standard, two drawers, coffee-grounds hopper optional
- Removable and fan assisted condenser unit
- Automatic evaporation of defrost water
- AISI-304 stainless steel worktop, with rounded front and 100 mm sanitary upstand (optional without upstand)
- Shelves made of plasticized steel wire, height adjustable by stainless steel supports
- AISI -304 adjustable legs, 125 to 200 mm
- Fan assisted evaporator, with epoxi anticorrosion coating.
- 40 Kg/m<sup>3</sup> density polyurethane insulation, zero ODP and GWP
- Digital temperature control, optimized defrost, high-temperature condensation alarm (FMRV). Efficient management of energy consumption
- Operating temperature, 32°C ambient

REFRIGERATED COUNTERS • MESAS REFRIGERADAS

|   |   |  |              |
|---|---|--|--------------|
|  | <p>Incremento precio por cambio de puerta a cajonera <b>doble</b> refrigerada inox desmontable sobre guías inox telescópicas, sistema auto-cierre</p> | <p><i>Increase of price by changing door to <b>double drawers set</b>, detachable telescopic SS runners, soft-closing system</i></p> | <p>670 €</p> |
|---|---|--|--------------|

| OPCIONES                     | OPTIONS                                  | €                   |
|------------------------------|--|---------------------|
| parrilla adicional           | extra shelf                              | 20 €                |
| cambio R134a por R290        | R134a to R290                            | + 5 %               |
| cajón tolva café por cajones | coffee-grounds hopper instead of drawers | 363 € x set         |
| cajonera doble auto-cierre   | double drawers set, soft-closing         | 670 € x set         |
| cerradura puerta cristal     | glass door lock                          | 46 € x ud           |
| motor lado izquierdo         | left side engine                         | 56 €                |
| encimera sin peto            | no upstand worktop                       | 0 €                 |
| set 4 ruedas                 | 4 castors set                            | 76 € x set          |
| set 6 ruedas                 | 6 castors set                            | 117 € x set         |
| registrador de alarmas HACCP | HACCP alarm recorder                     | 250 € x set         |
| tropicalizado 43°C           | tropicalized to 43°C                     | consultar - consult |
| 230v 60Hz / 115v 60Hz        | 230v 60Hz / 115v 60Hz                    | consultar - consult |
| respaldo inox                | stainless steel rear side                | consultar - consult |

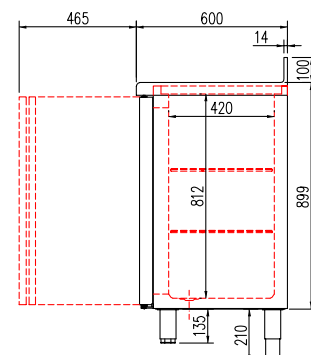

# FRENTE-MOSTRADOR SNACK, refrigeración cajones de cristal Chiller BACK BAR SNACK counter with glass drawers

1

all photos must be considered as a reference - fotografías no contractuales



FMRV-250



FMRV-250  
con dos sets de cajones dobles  
with two double glass drawers sets

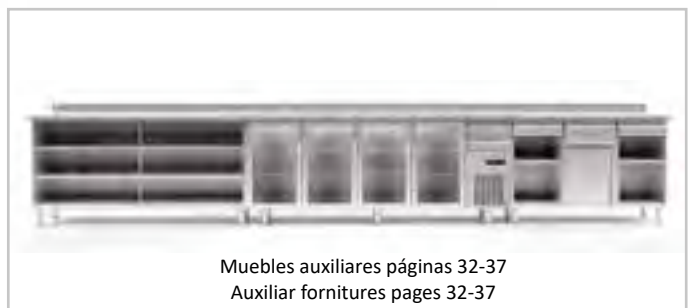

Muebles auxiliares páginas 32-37  
Auxiliar fornitures pages 32-37



**FMRP-120 1.515 €**

**FMRP-170 1.877 €**

**FMRP-220 2.203 €**

**FMRP-270 2.621 €**

**FMRPV-120 1.821 €**

**FMRPV-170 2.321 €**

**FMRPV-220 2.768 €**

**FMRPV-270 3.322 €**

| mod.           | rango range °C | largo length (mm) | alto height (mm) | fondo depth (mm) | estantes shelves | volumen capacity (L) | voltaje voltage | potencia frig. frig. power (-10°C) | refrigerante recomendado recommended refrigerant |
|----------------|----------------|-------------------|------------------|------------------|------------------|----------------------|-----------------|------------------------------------|--|
| FMRP/FMRPV-120 | -2°C +8°C      | 1195              | 1040             | 600              | 4                | 325                  | 230V-50Hz       | 300                                | R134a  |
| FMRP/FMRPV-170 | -2°C +8°C      | 1720              | 1040             | 600              | 6                | 504                  | 230V-50Hz       | 356                                | R134a  |
| FMRP/FMRPV-220 | -2°C +8°C      | 2245              | 1040             | 600              | 8                | 684                  | 230V-50Hz       | 485                                | R134a  |
| FMRP/FMRPV-270 | -2°C +8°C      | 2770              | 1040             | 600              | 10               | 863                  | 230V-50Hz       | 485                                | R134a  |

Características técnicas y constructivas sujetas a variación sin previo aviso.

We reserve the right to change specifications without prior notice.

**FMRP**

- Puerta en acero inox, contrapuerta embutida

**FMRPV**

- Puertas con doble cristal
- Luz interior estándar por LEDs

**COMUN**

- Unidad condensadora **NO INCLUIDA**, refrigerante recomendado R134a
- Control de expansión de refrigerante **NO INCLUIDO**
- Rendimiento del evaporador con  $\Delta t=12^{\circ}\text{C}$
- Exterior en acero inox AISI-304, excepto el respaldo
- Interior en acero inox AISI-304, con aristas curvas y fondo embutido
- Puertas de apertura reversible, con sistema de cierre automático y burlete magnético (permanece abierta al superar los  $90^{\circ}$  de apertura)
- Encimera de acero inox AISI-304 con frente curvo y peto trasero sanitario de 100 mm (opcional sin peto)
- Estantes interiores de alambre en acero plastificado, regulables en altura, sobre apoyos inox
- Pies en tubo de acero inox ajustables en altura 125 - 200 mm
- Evaporador sistema tiro forzado, con recubrimiento epoxi anticorrosión
- Aislamiento de poliuretano inyectado, densidad  $40\text{ Kg/m}^3$ , cero efectos ODP y GWP
- Control digital de temperatura, descarches optimizados, alarma por alta temperatura de condensación. Eficiente gestión del consumo de energía
- De serie, dotación de dos cajones neutros, opcional cajón tolva.
- Unidad condensadora ventilada y extraíble
- Evaporación automática del agua de descarche
- Temperatura de trabajo: FMRP  $38^{\circ}\text{C}$  ambiente  
FMRPV  $32^{\circ}\text{C}$  ambiente

**FMRP**

- Stainless steel doors, Inner side by stamped steel

**FMRPV**

- Double glazed doors
- LEDs lighting

**COMMON**

- Condenser unit **NOT INCLUDED**, recommended refrigerant R134a.
- Refrigerant expansion control, **NOT INCLUDED**
- Performance of the evaporator with  $\Delta t = 12^{\circ}\text{C}$
- AISI-304 stainless steel exterior, rear side galvanized panel
- AISI-304 stainless steel interior, stamped bottom and rounded corners
- Doors with self closing system, blocked opening, magnetic gasket and possibility of changing the opening sense
- AISI-304 stainless steel worktop, with rounded front and 100 mm sanitary upstand (optional without upstand)
- Shelves made of plasticized steel wire, height adjustable by stainless steel supports
- AISI -304 adjustable legs, 125 to 200 mm
- Fan assisted evaporator, with epoxi anticorrosion coating.
- $40\text{ Kg/m}^3$  density polyurethane insulation, zero ODP and GWP
- Digital temperature control, optimized defrost, high-temperature condensation alarm. Efficient management of energy consumption
- Standard, two drawers, coffee-grounds hopper optional
- Removable and fan assisted condenser unit
- Automatic evaporation of defrost water
- Operating temperature: FMRP  $38^{\circ}\text{C}$  ambiente  
FMRPV  $32^{\circ}\text{C}$  ambiente

| OPCIONES                           | OPTIONS                              | €                   |
|------------------------------------|--------------------------------------|---------------------|
| parrilla adicional                 | extra shelf                          | 20 €                |
| cajonera doble inox, auto-cierre   | double drawers set, soft-closing     | 363 € x set         |
| cajonera triple inox, auto-cierre  | triple drawers set, soft-closing     | 537 € x set         |
| cajonera cristal, auto-cierre      | glazed drawers set, soft-closing     | 670 € x set         |
| cerradura puerta inox              | solid door lock                      | 15 € x ud           |
| cerradura puerta cristal           | glass door lock                      | 46 € x ud           |
| conexiones lado izquierdo          | left side connections                | 56 €                |
| encimera sin peto                  | no upstand worktop                   | 0 €                 |
| set 4 ruedas                       | 4 castors set                        | 76 € x set          |
| set 6 ruedas                       | 6 castors set                        | 117 € x set         |
| registrador de alarmas HACCP       | HACCP alarm recorder                 | 250 € x set         |
| tropicalizado $43^{\circ}\text{C}$ | tropicalized to $43^{\circ}\text{C}$ | consultar - consult |
| 230v 60Hz / 115v 60Hz              | 230v 60Hz / 115v 60Hz                | consultar - consult |
| respaldo inox                      | stainless steel rear side            | consultar - consult |
| evaporación automática             | defrost water evaporation            | 95 €                |

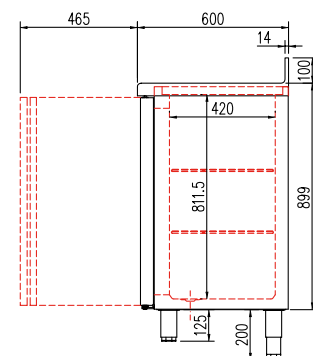

# FRENTE-MOSTRADOR SNACK, refrigeración, con cajones Chiller BACK BAR SNACK counter with drawers

1

all photos must be considered as a reference - fotografías no contractuales



FMRVP-220



FMRP-220

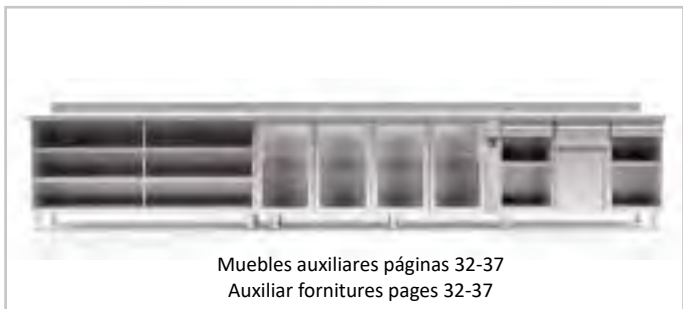

Muebles auxiliares páginas 32-37  
Auxiliar furnitures pages 32-37



MCC-50-C 428 €



MCC-50-T 428 €



MCC-90 718 €



MCC-140 1.128 €

| mod.     | largo<br>length<br>(mm) | alto<br>height<br>(mm) | fondo<br>depth<br>(mm) | cajones<br>drawers | tolva<br>hopper | puertas<br>doors |
|----------|-------------------------|------------------------|------------------------|--------------------|-----------------|------------------|
| MCC-50-T | 475                     | 1040                   | 600                    | 0                  | 1               | 1                |
| MCC-50-C | 475                     | 1040                   | 600                    | 2                  | 0               | 1                |
| MCC-90   | 915                     | 1040                   | 600                    | 2                  | 1               | 2                |
| MCC-140  | 1375                    | 1040                   | 600                    | 4                  | 1               | 2                |

REFRIGERATED COUNTERS • MESAS REFRIGERADAS

Características técnicas y constructivas sujetas a variación sin previo aviso.

- Módulos de diseño compacto
  - Exterior y estantes en acero inox AISI-304, excepto el respaldo
  - Respaldo en acero plastificado
  - Encimera de acero inox AISI-304 con frente curvo y peto trasero sanitario de 100 mm (Opcional sin peto)
  - Cajones con guías de rodamientos
  - Cajón tolva para café, desmontable
  - Cajones y tolva, son intercambiables
  - Pies en tubo de acero inox ajustables en altura 125 - 200 mm
- Pueden fabricarse, bajo pedido, en diferentes medidas

MC-50-T: 1 x cajón tolva para café  
 MC-50-C: 2 x cajones con guías

We reserve the right to change specifications without prior notice.

- Compact designed modules
  - AISI-304 stainless steel exterior and shelf, except the rear side
  - Rear panel in plasticized steel
  - AISI-30418/10 stainless steel worktop, with rounded front and 100 mm sanitary upstand (optional without upstand)
  - Drawers with slides
  - Detachable coffee sediment special drawer with hitting surface
  - Interchangeable drawers (auxiliary and coffee)
  - AISI -304 adjustable legs, 125 to 200 mm
- Can be produced on request, in different measures

MC-50-T: 1 x coffe-grounds special drawer  
 MC-50-C: 2 x drawers with slides

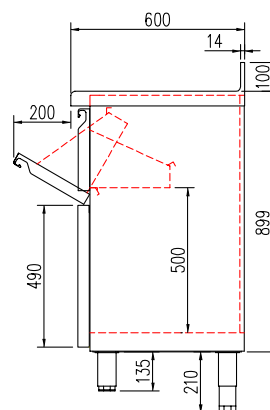
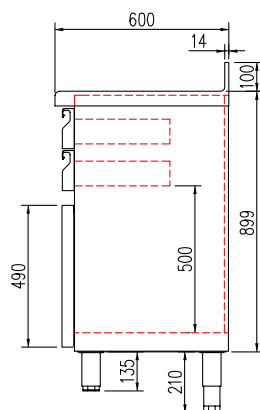

all photos must be considered as a reference - fotografías no contractuales



MCC-50-T



MCC-90



FMR-150 + MCC-50T  
Encimera especial  
Special worktop



MCC-140

Forma línea con mesas frías gama FMR y FMRV, páginas 30 - 35 • Match with refrigerated counters FMR and FMRV pages 30 - 35





|          |       |
|----------|-------|
| MC-100   | 728 € |
| MC-100-2 | 744 € |



|          |       |
|----------|-------|
| MC-150   | 889 € |
| MC-150-2 | 925 € |

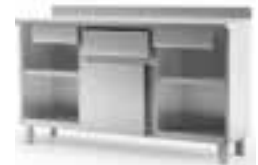

|          |         |
|----------|---------|
| MC-200   | 1.023 € |
| MC-200-2 | 1.059 € |

| mod.     | largo<br>length<br>(mm) | alto<br>height<br>(mm) | fondo<br>depth<br>(mm) | cajones<br>drawers | tolva<br>hopper | estantes<br>shelves | puertas<br>doors |
|----------|-------------------------|------------------------|------------------------|--------------------|-----------------|---------------------|------------------|
| MC-100   | 990                     | 1040                   | 600                    | 1                  | 1               | 1                   | 1                |
| MC-150   | 1495                    | 1040                   | 600                    | 2                  | 1               | 2                   | 1                |
| MC-200   | 2020                    | 1040                   | 600                    | 2                  | 1               | 2                   | 1                |
| MC-100-2 | 990                     | 1040                   | 600                    | 1                  | 1               | 2                   | 1                |
| MC-150-2 | 1495                    | 1040                   | 600                    | 2                  | 1               | 4                   | 1                |
| MC-200-2 | 2020                    | 1040                   | 600                    | 2                  | 1               | 4                   | 1                |

Características técnicas y constructivas sujetas a variación sin previo aviso.

- Exterior en acero inox AISI-304, excepto el respaldo.
- Respaldo en acero plastificado.
- Apoyos inox, regulables en altura.
- Cajones auxiliares sobre guías con rodamientos.
- Tolva para café con golpeador.
- MC - Un estante intermedio.
- MC-2 - Dos estantes intermedios.

Pueden fabricarse, bajo pedido, en diferentes medidas

We reserve the right to change specifications without prior notice.

- AISI-304 stainless steel exterior and shelf, except the rear side
- Plasticised steel backing.
- Height-adjustable stainless steel supports.
- Auxiliary drawers on guides with wheels.
- Coffee sediment special drawer with hitting surface
- MC - One intermediate shelf.
- MC-2 - Two intermediate shelves.

Can be produced on request, in different measures

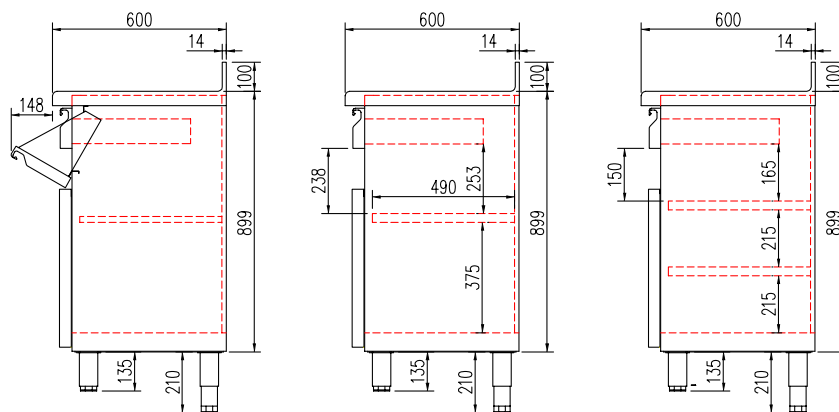

all photos must be considered as a reference - fotografías no contractuales



MC - 150



Forma línea con mesas frías gama FMR y FMRV, páginas 26 - 31 • Match with refrigerated counters FMR and FMRV pages 26-31



|             |       |
|-------------|-------|
| EFM60-100   | 506 € |
| EFM60-100-2 | 584 € |
| EFM35-100   | 388 € |
| EFM35-100-2 | 439 € |



|             |       |
|-------------|-------|
| EFM60-150   | 625 € |
| EFM60-150-2 | 687 € |
| EFM35-150   | 542 € |
| EFM35-150-2 | 589 € |



|             |       |
|-------------|-------|
| EFM60-200   | 776 € |
| EFM60-200-2 | 852 € |
| EFM35-200   | 693 € |
| EFM35-200-2 | 728 € |

| mod.<br><b>60</b> | largo<br>length<br>(mm) | alto<br>height<br>(mm) | fondo<br>depth<br>(mm) | estantes<br>shelves |
|-------------------|-------------------------|------------------------|------------------------|---------------------|
| EFM60-100         | 990                     | 1040                   | 600                    | 1                   |
| EFM60-150         | 1495                    | 1040                   | 600                    | 1                   |
| EFM60-200         | 2020                    | 1040                   | 600                    | 1                   |
| EFM60-100-2       | 990                     | 1040                   | 600                    | 2                   |
| EFM60-150-2       | 1495                    | 1040                   | 600                    | 2                   |
| EFM60-200-2       | 2020                    | 1040                   | 600                    | 2                   |

| mod.<br><b>35</b> | largo<br>length<br>(mm) | alto<br>height<br>(mm) | fondo<br>depth<br>(mm) | estantes<br>shelves |
|-------------------|-------------------------|------------------------|------------------------|---------------------|
| EFM35-100         | 990                     | 1040                   | 350                    | 1                   |
| EFM35-150         | 1495                    | 1040                   | 350                    | 1                   |
| EFM35-200         | 2020                    | 1040                   | 350                    | 1                   |
| EFM35-100-2       | 990                     | 1040                   | 350                    | 2                   |
| EFM35-150-2       | 1495                    | 1040                   | 350                    | 2                   |
| EFM35-200-2       | 2020                    | 1040                   | 350                    | 2                   |

Características técnicas y constructivas sujetas a variación sin previo aviso.

- Exterior y estantes en acero inox AISI-304, excepto el respaldo
- Respaldo en acero plastificado
- Encimera de acero inox AISI-304 con frente curvo y peto trasero sanitario de 100 mm (Opcional sin peto)
- Pies en tubo de acero inox ajustables en altura 125 - 200 mm
- EFM-2: de serie dos estantes
- Pueden fabricarse, bajo pedido, en diferentes medidas

We reserve the right to change specifications without prior notice.

- AISI-304 stainless steel exterior and shelves, except the rear side
- Rear panel in plasticized steel
- AISI-30418/10 stainless steel worktop, with rounded front and 100 mm sanitary upstand (optional without upstand)
- AISI -304 adjustable legs, 125 to 200 mm
- EFM-2: two shelves as standard
- Can be produced on request, in different measures

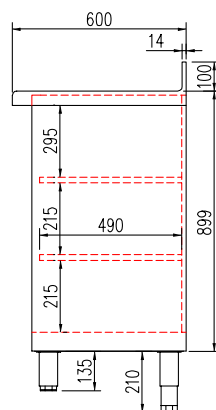

EFM60-2

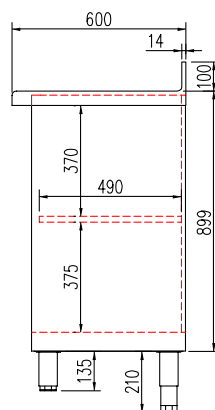

EFM60

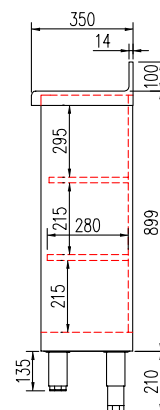

EFM35-2

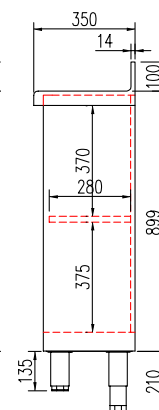

EFM35

all photos must be considered as a reference - fotografías no contractuales



EFM60 -200 - 2



EFM35 -150



Forma línea con mesas frías gama FMR y FMRV, páginas 26 - 31 • Match with refrigerated counters FMR and FMRV pages 26 - 31



**HMRG-150 2.488 €**

**HMRG-200 2.856 €**

| mod.     | rango range °C | largo length (mm) | alto height (mm) | fondo depth (mm) | estantes shelves GN 1/1 | pares guías slides sets | volumen capacity (L) | voltaje voltage | refrigerante refrigerant | potencia frig. frig. power W | potencia power W | CCE EEC 2015/1094 EN16825 |
|----------|----------------|-------------------|------------------|------------------|-------------------------|-------------------------|----------------------|-----------------|--------------------------|------------------------------|------------------|---------------------------|
| HMRG-150 | -2°C<br>+8°C   | 1395              | 850              | 700              | 2                       | 2                       | 255                  | 230V-50Hz       | R290                     | 280                          | 161              | A                         |
| HMRG-200 | -2°C<br>+8°C   | 1795              | 850              | 700              | 3                       | 3                       | 399                  | 230V-50Hz       | R290                     | 280                          | 164              | A                         |

Características técnicas y constructivas sujetas a variación sin previo aviso.

We reserve the right to change specifications without prior notice.

REFRIGERATED COUNTERS • MESAS REFRIGERADAS

- Exterior en acero inox AISI-304, excepto el respaldo
  - Interior en acero inox AISI-304, con aristas curvas y fondo embutido
  - Puertas de apertura reversible, con sistema de cierre automático y burlete magnético (permanece abierta al superar los 90° de apertura)
  - Contrapuerta inox embutida
  - Cajoneras refrigeradas OPCIONALES, inox desmontables sobre guías inox telescópicas, sistema auto-cierre de serie
  - Encimera de acero inox AISI-304 con frente curvo y peto trasero sanitario de 100 mm (opcional sin peto)
  - Estantes interiores GN 1/1 de alambre en acero plastificado, regulables en altura,
  - Pies en tubo de acero inox ajustables en altura 125 - 200 mm
  - Unidad condensadora ventilada y extraíble
  - Evaporador sistema tiro forzado, con recubrimiento epoxi anticorrosión
  - Evaporación automática del agua de descarche
  - Aislamiento de poliuretano inyectado, densidad 40 Kg/m<sup>3</sup>, cero efectos ODP y GWP
  - Control digital de temperatura, descarches optimizados, alarma por alta temperatura de condensación. Eficiente gestión del consumo de energía
  - Ventiladores alta eficiencia
  - Temperatura de trabajo 16°C a 43°C ambiente
- AISI-304 stainless steel exterior, rear side galvanized panel
  - AISI-304 stainless steel interior, stamped bottom and rounded corners
  - Doors with self closing system, blocked opening, magnetic gasket and possibility of changing the opening sense
  - Inner side of doors by stamped steel
  - OPTIONAL Stainless steel drawers with telescopic stainless steel slides for complete opening, soft-closing system as standard
  - AISI-304 stainless steel worktop, with rounded front and 100 mm sanitary upstand (optional without upstand)
  - GN 1/1 shelves made of plasticized steel wire, height adjustable
  - AISI -304 adjustable legs, 125 to 200 mm
  - Removable and fan assisted condenser unit
  - Fan assisted evaporator, with epoxi anticorrosion coating.
  - Automatic evaporation of defrost water
  - 40 Kg/m<sup>3</sup> density polyurethane insulation, zero ODP and GWP
  - Digital temperature control, optimized defrost, high-temperature condensation alarm. Efficient management of energy consumption
  - High efficiency fan motors
  - Operating temperature 16°C a 43°C ambient

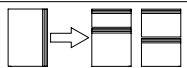
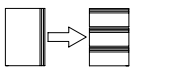
|   |   |   |       |
|---|---|---|-------|
|  | Incremento precio por cambio de puerta a cajonera <b>doble</b> refrigerada inox desmontable sobre guías inox telescópicas, sistema auto-cierre  | <i>Increase of price by changing door to <b>double</b> drawers set, detachable telescopic SS runners, soft-closing system</i> | 455 € |
|  | Incremento precio por cambio de puerta a cajonera <b>triple</b> refrigerada inox desmontable sobre guías inox telescópicas, sistema auto-cierre | <i>Increase of price by changing door to <b>triple</b> drawers set, detachable telescopic SS runners, soft-closing system</i> | 604 € |

| OPCIONES                     | OPTIONS                          | €                          |
|------------------------------|----------------------------------|----------------------------|
| parrilla suplemento          | <i>extra shelf supplement</i>    | 18 € x ud                  |
| parrilla adicional GN 1/1    | <i>GN 1/1 extra shelf</i>        | 23 € x ud                  |
| set adicional guías GN 1/1   | <i>GN 1/1 slides extra set</i>   | 25 € x set                 |
| cerradura puerta             | <i>door lock</i>                 | 15 € x ud                  |
| motor lado izquierdo         | <i>left side engine</i>          | 56 €                       |
| encimera sin peto            | <i>no upstand worktop</i>        | 0 €                        |
| set 4 ruedas                 | <i>4 castors set</i>             | 76 € x set                 |
| set 6 ruedas                 | <i>6 castors set</i>             | 117 € x set                |
| registrador de alarmas HACCP | <i>HACCP alarm recorder</i>      | 250 € x set                |
| tropicalizado 43°C           | <i>tropicalized to 43°C</i>      | consultar - <i>consult</i> |
| 230v 60Hz / 115v 60Hz        | <i>230v 60Hz / 115v 60Hz</i>     | consultar - <i>consult</i> |
| respaldo inox                | <i>stainless steel rear side</i> | consultar - <i>consult</i> |



Mesa fría GN 1/1 ALTA EFICIENCIA  
GN 1/1 HIGH EFFICIENCY chiller counter

1

all photos must be considered as a reference - fotografías no contractuales



HMRG-200



HMRG-150

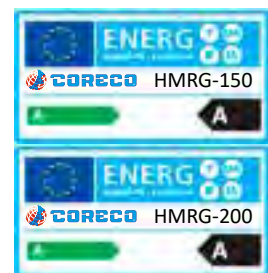



|          |         |
|----------|---------|
| MRG-150  | 1.996 € |
| MRGF-150 | 2.192 € |
| MCG-150  | 2.616 € |

|          |         |
|----------|---------|
| MRG-200  | 2.367 € |
| MRGF-200 | 2.574 € |
| MCG-200  | 3.071 € |

|          |         |
|----------|---------|
| MRG-250  | 2.808 € |
| MRGF-250 | 2.947 € |

|          |         |
|----------|---------|
| MRG-300  | 3.164 € |
| MRGF-300 | 3.433 € |

| mod.    | rango range °C | largo length (mm) | alto height (mm) | fondo depth (mm) | estantes shelves GN 1/1 | pares guías slides sets | volumen capacity (L) | voltaje voltage | refrigerante refrigerant | potencia frig. frig. power W | potencia power W | CCE EEC 2015/1094 EN16825 |
|---------|----------------|-------------------|------------------|------------------|-------------------------|-------------------------|----------------------|-----------------|--------------------------|------------------------------|------------------|---------------------------|
| MRG-150 | -2°C +8°C      | 1345              | 850              | 700              | 2                       | 2                       | 255                  | 230V-50Hz       | R134a                    | 178                          | 211              | C                         |
|         |                |                   |                  |                  |                         |                         |                      |                 | R290*                    | 280                          | 218              | B                         |
| MRG-200 | -2°C +8°C      | 1795              | 850              | 700              | 3                       | 3                       | 399                  | 230V-50Hz       | R134a                    | 245                          | 249              | C                         |
|         |                |                   |                  |                  |                         |                         |                      |                 | R290*                    | 280                          | 220              | B                         |
| MRG-250 | -2°C +8°C      | 2245              | 850              | 700              | 4                       | 4                       | 543                  | 230V-50Hz       | R134a                    | 304                          | 289              | C                         |
|         |                |                   |                  |                  |                         |                         |                      |                 | R290*                    | 739                          | 412              | C                         |
| MRG-300 | -2°C +8°C      | 2695              | 850              | 700              | 5                       | 5                       | 686                  | 230V-50Hz       | R134a                    | 356                          | 304              | C                         |
|         |                |                   |                  |                  |                         |                         |                      |                 | R290*                    | 739                          | 416              | C                         |
| MCG-150 | -20°C -15°C    | 1345              | 850              | 700              | 2                       | 2                       | 255                  | 230V-50Hz       | R290                     | 606                          | 535              | E                         |
|         |                |                   |                  |                  |                         |                         |                      |                 | R452A*                   | 353                          | 556              | F                         |
| MCG-200 | -20°C -15°C    | 1795              | 850              | 700              | 3                       | 3                       | 399                  | 230V-50Hz       | R290                     | 606                          | 556              | D                         |
|         |                |                   |                  |                  |                         |                         |                      |                 | R452A*                   | 452                          | 610              | F                         |

\*opcional - optional

Características técnicas y constructivas sujetas a variación sin previo aviso.

We reserve the right to change specifications without prior notice.

REFRIGERATED COUNTERS • MESAS REFRIGERADAS

- Exterior en acero inox AISI-304, excepto el respaldo
- Interior en acero inox AISI-304, con aristas curvas y fondo embutido
- Puertas de apertura reversible, con sistema de cierre automático y burlete magnético (permanece abierta al superar los 90° de apertura)
- Contrapuerta inox embutida
- Encimera de acero inox AISI-304 con frente curvo y peto trasero sanitario de 100 mm (opcional sin peto)
- Estantes interiores GN 1/1 de alambre en acero plastificado, regulables en altura
- Pies en tubo de acero inox ajustables en altura 125 - 200 mm
- Unidad condensadora ventilada y extraíble
- Evaporador sistema tiro forzado, con recubrimiento epoxi anticorrosión
- Evaporación automática del agua de descarche
- Aislamiento de poliuretano inyectado, densidad 40 Kg/m<sup>3</sup>, cero efectos ODP y GWP
- Control digital de temperatura, descarches optimizados, alarma por alta temperatura de condensación. Eficiente gestión del consumo de energía
- Temperatura de trabajo: 38°C ambiente

- AISI-304 stainless steel exterior, rear side galvanized panel
- AISI-304 stainless steel interior, stamped bottom and rounded corners
- Doors with self closing system, blocked opening, magnetic gasket and possibility of changing the opening sense
- Inner side of doors by stamped steel
- AISI-304 stainless steel worktop, with rounded front and 100 mm sanitary upstand (optional without upstand)
- GN 1/1 shelves made of plasticized steel wire, height adjustable
- AISI -304 adjustable legs, 125 to 200 mm
- Removable and fan assisted condenser unit
- Fan assisted evaporator, with epoxi anticorrosion coating.
- Automatic evaporation of defrost water
- 40 Kg/m<sup>3</sup> density polyurethane insulation, zero ODP and GWP
- Digital temperature control, optimized defrost, high-temperature condensation alarm. Efficient management of energy consumption
- Operating temperature: 38°C ambient

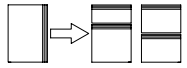
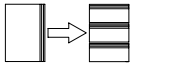
|   |   |  |       |
|---|---|--|-------|
|  | Incremento precio por cambio de puerta a cajonera <b>double</b> refrigerada inox desmontable sobre guías inox telescópicas, sistema auto-cierre | Increase of price by changing door to <b>double</b> drawers set, detachable telescopic SS runners, soft-closing system | 455 € |
|  | Incremento precio por cambio de puerta a cajonera <b>triple</b> refrigerada inox desmontable sobre guías inox telescópicas, sistema auto-cierre | Increase of price by changing door to <b>triple</b> drawers set, detachable telescopic SS runners, soft-closing system | 604 € |

| OPCIONES                         | OPTIONS                   | €                   |
|----------------------------------|---------------------------|---------------------|
| parrilla suplemento              | extra shelf supplement    | 18 € x ud           |
| cambio R134a por R290            | R134a to R290             | + 5 %               |
| cambio R290 por R452A            | R290 to R452A             | 0 %                 |
| parrilla adicional GN 1/1        | GN 1/1 extra shelf        | 23 € x ud           |
| set adicional guías GN 1/1       | GN 1/1 slides extra set   | 25 € x set          |
| cerradura puerta                 | door lock                 | 15 € x ud           |
| motor lado izquierdo             | left side engine          | 56 €                |
| motor lado izquierdo + fregadero | left side engine + sink   | 414 €               |
| encimera sin peto                | no upstand worktop        | 0 €                 |
| set 4 ruedas                     | 4 castors set             | 76 € x set          |
| set 6 ruedas                     | 6 castors set             | 117 € x set         |
| registrador de alarmas HACCP     | HACCP alarm recorder      | 250 € x set         |
| tropicalizado 43°C               | tropicalized to 43°C      | consultar - consult |
| 230v 60Hz / 115v 60Hz            | 230v 60Hz / 115v 60Hz     | consultar - consult |
| pre-instalación                  | remote compressor         | consultar - consult |
| respaldo inox                    | stainless steel rear side | consultar - consult |

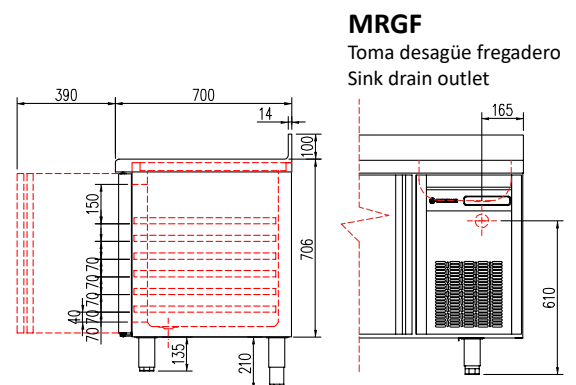

all photos must be considered as a reference - fotografías no contractuales



MRG-200

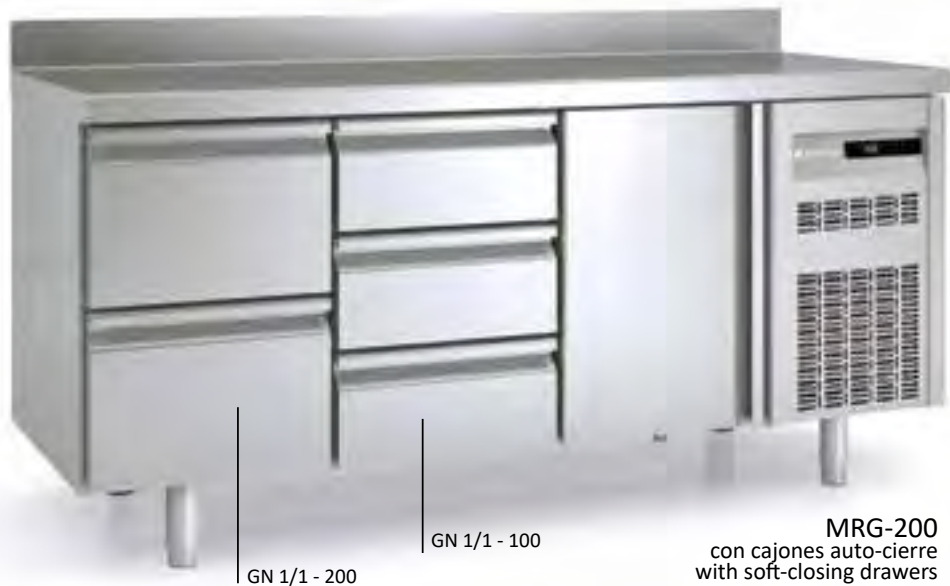

MRG-200  
con cajones auto-cierre  
with soft-closing drawers

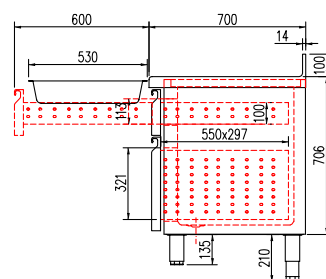
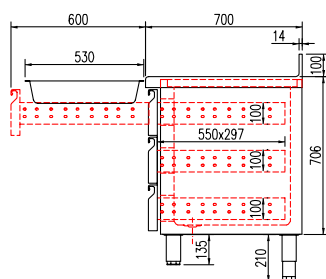
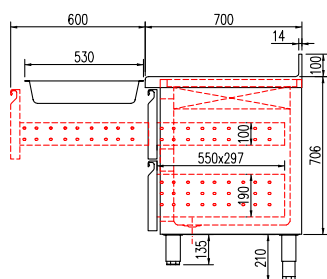
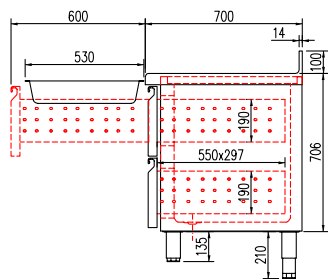

Pre-instalación opcional  
Optional remote compressor



MRGF

Fregadero 340 x 360 x 160  
340 x 360 x 160 Sink





|          |         |
|----------|---------|
| MRGV-150 | 2.299 € |
| MCGV-150 | 2.939 € |

|          |         |
|----------|---------|
| MRGV-200 | 2.779 € |
| MCGV-200 | 3.552 € |

|          |         |
|----------|---------|
| MRGV-250 | 3.333 € |
| MCGV-250 | 4.206 € |

|          |         |
|----------|---------|
| MRGV-300 | 3.839 € |
|----------|---------|

| mod.     | rango range °C | largo length (mm) | alto height (mm) | fondo depth (mm) | estantes shelves GN 1/1 | pares guías slides sets | volumen capacity (L) | voltaje voltage | refrigerante refrigerant | potencia frig. frig. power W | potencia power W |
|----------|----------------|-------------------|------------------|------------------|-------------------------|-------------------------|----------------------|-----------------|--------------------------|------------------------------|------------------|
| MRGV-150 | -2°C +8°C      | 1345              | 850              | 700              | 2                       | 2                       | 255                  | 230V-50Hz       | R134a                    | 245                          | 262              |
|          |                |                   |                  |                  |                         |                         |                      |                 | R290*                    | 280                          | 221              |
| MRGV-200 | -2°C +8°C      | 1795              | 850              | 700              | 3                       | 3                       | 399                  | 230V-50Hz       | R134a                    | 304                          | 306              |
|          |                |                   |                  |                  |                         |                         |                      |                 | R290*                    | 502                          | 246              |
| MRGV-250 | -2°C +8°C      | 2245              | 850              | 700              | 4                       | 4                       | 543                  | 230V-50Hz       | R134a                    | 485                          | 447              |
|          |                |                   |                  |                  |                         |                         |                      |                 | R290*                    | 739                          | 422              |
| MRGV-300 | -2°C +8°C      | 2695              | 850              | 700              | 5                       | 5                       | 686                  | 230V-50Hz       | R134a                    | 485                          | 451              |
|          |                |                   |                  |                  |                         |                         |                      |                 | R290*                    | 739                          | 426              |
| MCGV-150 | -20°C -15°C    | 1345              | 850              | 700              | 2                       | 2                       | 255                  | 230V-50Hz       | R290                     | 606                          | 544              |
|          |                |                   |                  |                  |                         |                         |                      |                 | R452A*                   | 353                          | 565              |
| MCGV-200 | -20°C -15°C    | 1795              | 850              | 700              | 3                       | 3                       | 399                  | 230V-50Hz       | R290                     | 606                          | 548              |
|          |                |                   |                  |                  |                         |                         |                      |                 | R452A*                   | 452                          | 623              |

\*opcional - optional

Características técnicas y constructivas sujetas a variación sin previo aviso.

We reserve the right to change specifications without prior notice.

- Exterior en acero inox AISI-304, excepto el respaldo
- Interior en acero inox AISI-304, con aristas curvas y fondo embutido
- Puertas de apertura reversible, con sistema de cierre automático y burlete magnético (permanece abierta al superar los 90° de apertura)
- Puertas doble cristal + LEDs
- Encimera de acero inox AISI-304 con frente curvo y peto trasero sanitario de 100 mm (opcional sin peto)
- Estantes interiores GN 1/1 de alambre en acero plastificado, regulables en altura
- Pies en tubo de acero inox ajustables en altura 125 - 200 mm
- Unidad condensadora ventilada y extraíble
- Evaporador sistema tiro forzado, con recubrimiento epoxi anticorrosión
- Evaporación automática del agua de descarche
- Aislamiento de poliuretano inyectado, densidad 40 Kg/m<sup>3</sup>, cero efectos ODP y GWP
- Control digital de temperatura, descarches optimizados, alarma por alta temperatura de condensación. Eficiente gestión del consumo de energía
- Temperatura de trabajo: 32°C ambiente

- AISI-304 stainless steel exterior, rear side galvanized panel
- AISI-304 stainless steel interior, stamped bottom and rounded corners
- Doors with self closing system, blocked opening, magnetic gasket and possibility of changing the opening sense
- Double glazed doors + LEDs
- AISI-304 stainless steel worktop, with rounded front and 100 mm sanitary upstand (optional without upstand)
- GN 1/1 shelves made of plasticized steel wire, height adjustable
- AISI -304 adjustable legs, 125 to 200 mm
- Removable and fan assisted condenser unit
- Fan assisted evaporator, with epoxi anticorrosion coating.
- Automatic evaporation of defrost water
- 40 Kg/m<sup>3</sup> density polyurethane insulation, zero ODP and GWP
- Digital temperature control, optimized defrost, high-temperature condensation alarm. Efficient management of energy consumption
- Operating temperature: 32°C ambient

| OPCIONES                     | OPTIONS                   | €                   |
|------------------------------|---------------------------|---------------------|
| parrilla suplemento          | extra shelf supplement    | 18 € x ud           |
| cambio R134a por R290        | R134a to R290             | + 5 %               |
| cambio R290 por R452A        | R290 to R452A             | 0 %                 |
| parrilla adicional GN 1/1    | GN 1/1 extra shelf        | 23 € x ud           |
| set adicional guías GN 1/1   | GN 1/1 slides extra set   | 25 € x set          |
| cerradura puerta cristal     | glass door lock           | 45 € x ud           |
| motor lado izquierdo         | left side engine          | 56 €                |
| encimera sin peto            | no upstand worktop        | 0 €                 |
| set 4 ruedas                 | 4 castors set             | 76 € x set          |
| set 6 ruedas                 | 6 castors set             | 117 € x set         |
| registrador de alarmas HACCP | HACCP alarm recorder      | 250 € x set         |
| 230v 60Hz / 115v 60Hz        | 230v 60Hz / 115v 60Hz     | consultar - consult |
| pre-instalación              | remote compressor         | consultar - consult |
| respaldo inox                | stainless steel rear side | consultar - consult |

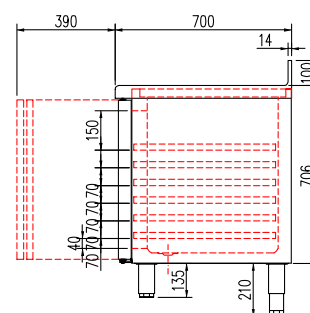

all photos must be considered as a reference - fotografías no contractuales



**MRGV-250**  
dotación parrillas y contenedores extra  
with extra containers and shelves

Pre-instalación opcional  
*Optional remote compressor*





MFCG-150 2.399 €



MFCG-200 2.803 €



MFCG-250 3.397 €



MFCG-300 3.971 €

| mod.     | rango range °C | largo length (mm) | alto height (mm) | fondo depth (mm) | estantes shelves GN 1/1 | pares guías slides sets | volumen capacity (L) | voltaje voltage | refrigerante refrigerant | potencia frig. frig. power W | potencia power W |
|----------|----------------|-------------------|------------------|------------------|-------------------------|-------------------------|----------------------|-----------------|--------------------------|------------------------------|------------------|
| MFCG-150 | -2°C +8°C      | 1345              | 850              | 780              | 2                       | 2                       | 255                  | 230V-50Hz       | R134a                    | 304                          | 293              |
|          |                |                   |                  |                  |                         |                         |                      |                 | R290*                    | 502                          | 239              |
| MFCG-200 | -2°C +8°C      | 1795              | 850              | 780              | 3                       | 3                       | 399                  | 230V-50Hz       | R134a                    | 304                          | 293              |
|          |                |                   |                  |                  |                         |                         |                      |                 | R290*                    | 502                          | 239              |
| MFCG-250 | -2°C +8°C      | 2245              | 850              | 780              | 4                       | 4                       | 543                  | 230V-50Hz       | R134a                    | 485                          | 429              |
|          |                |                   |                  |                  |                         |                         |                      |                 | R290*                    | 739                          | 410              |
| MFCG-300 | -2°C +8°C      | 2695              | 850              | 780              | 5                       | 5                       | 686                  | 230V-50Hz       | R134a                    | 485                          | 431              |
|          |                |                   |                  |                  |                         |                         |                      |                 | R290*                    | 739                          | 410              |

\*opcional - optional

Características técnicas y constructivas sujetas a variación sin previo aviso.

We reserve the right to change specifications without prior notice.

- Exterior en acero inox AISI-304, excepto el respaldo
- Interior en acero inox AISI-304, con aristas curvas y fondo embutido
- Puertas de apertura reversible, con sistema de cierre automático y burlete magnético (permanece abierta al superar los 90° de apertura)
- Contrapuerta inox embutida
- Encimera de acero inox AISI-304 con frentes curvos
- Estantes interiores GN 1/1 de alambre en acero plastificado, regulables en altura
- Pies en tubo de acero inox ajustables en altura 125 - 200 mm
- Unidad condensadora ventilada y extraíble
- Evaporador sistema tiro forzado, con recubrimiento epoxi anticorrosión
- Evaporación automática del agua de descarche
- Aislamiento de poliuretano inyectado, densidad 40 Kg/m<sup>3</sup>, cero efectos ODP y GWP
- Control digital de temperatura, descarches optimizados, alarma por alta temperatura de condensación. Eficiente gestión del consumo de energía
- Temperatura de trabajo a 38°C ambiente

- AISI-304 stainless steel exterior, rear side galvanized panel
- AISI-304 stainless steel interior, stamped bottom and rounded corners
- Doors with self closing system, blocked opening, magnetic gasket and possibility of changing the opening sense
- Inner side of doors by stamped steel
- AISI-304 stainless steel worktop, with rounded fronts
- GN 1/1 shelves made of plasticized steel wire, height adjustable
- AISI -304 adjustable legs, 125 to 200 mm
- Removable and fan assisted condenser unit
- Fan assisted evaporator, with epoxi anticorrosion coating.
- Automatic evaporation of defrost water
- 40 Kg/m<sup>3</sup> density polyurethane insulation, zero ODP and GWP
- Digital temperature control, optimized defrost, high-temperature condensation alarm. Efficient management of energy consumption
- Operating temperature 38°C ambient

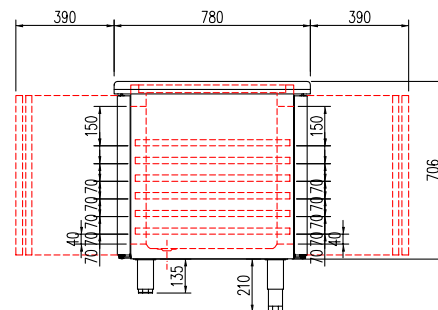

Pre-instalación opcional  
Optional remote compressor



| OPCIONES                         | OPTIONS                   | €                   |
|----------------------------------|---------------------------|---------------------|
| parrilla suplemento              | extra shelf supplement    | 18 € x ud           |
| parrilla adicional GN 1/1        | GN 1/1 extra shelf        | 23 € x ud           |
| set adicional guías GN 1/1       | GN 1/1 slides extra set   | 25 € x set          |
| cambio R134a por R290            | R134a to R290             | + 5 %               |
| cerradura puerta                 | door lock                 | 15 € x ud           |
| motor lado izquierdo             | left side engine          | 56 €                |
| encimera con fregadero           | worktop with sink         | consultar - consult |
| motor lado izquierdo + fregadero | left side engine + sink   | consultar - consult |
| set 4 ruedas                     | 4 castors set             | 76 € x set          |
| set 6 ruedas                     | 6 castors set             | 117 € x set         |
| registrador de alarmas HACCP     | HACCP alarm recorder      | 250 € x set         |
| tropicalizado 43°C               | tropicalized to 43°C      | consultar - consult |
| 230v 60Hz / 115v 60Hz            | 230v 60Hz / 115v 60Hz     | consultar - consult |
| pre-instalación                  | remote compressor         | consultar - consult |
| respaldo inox                    | stainless steel rear side | consultar - consult |

all photos must be considered as a reference - fotografías no contractuales



MFCG-250  
puerta de cristal a 1 cara (opcional) vista trasera  
glass doors (option), rear view



MFCG-250



Fregadero 340 x 360 x 160  
340 x 360 x 160 Sink

optional





|         |         |
|---------|---------|
| MF-100  | 1.691 € |
| MFV-100 | 1.943 € |

|          |         |
|----------|---------|
| MFC-100  | 1.747 € |
| MFCV-100 | 2.002 € |

|         |         |
|---------|---------|
| MF-140  | 1.898 € |
| MFV-140 | 2.268 € |

|          |         |
|----------|---------|
| MFC-140  | 2.037 € |
| MFCV-140 | 2.412 € |

| mod.    | rango range °C | largo length (mm) | alto height (mm) | fondo depth (mm) | estantes shelves GN 1/1 | pares guías slides sets | volumen capacity (L) | voltaje voltage | refrigerante refrigerant | potencia frig. frig. power W | potencia power W | CCE EEC 2015/1094 EN16825 |
|---------|----------------|-------------------|------------------|------------------|-------------------------|-------------------------|----------------------|-----------------|--------------------------|------------------------------|------------------|---------------------------|
| MF-100  | -2°C +8°C      | 915               | 870              | 700              | 2                       | 2                       | 169                  | 230V-50Hz       | R134a                    | 304                          | 314              | D                         |
|         |                |                   |                  |                  |                         |                         |                      |                 | R290*                    | 502                          | 277              | D                         |
| MFC-100 | -2°C +8°C      | 915               | 950              | 700              | 2                       | 2                       | 255                  | 230V-50Hz       | R134a                    | 304                          | 314              | D                         |
|         |                |                   |                  |                  |                         |                         |                      |                 | R290*                    | 502                          | 277              | D                         |
| MF-140  | -2°C +8°C      | 1395              | 870              | 700              | 3                       | +3                      | 264                  | 230V-50Hz       | R134a                    | 485                          | 503              | F                         |
|         |                |                   |                  |                  |                         |                         |                      |                 | R290*                    | 820                          | 580              | F                         |
| MFC-140 | -2°C +8°C      | 1395              | 950              | 700              | 3                       | 3                       | 399                  | 230V-50Hz       | R134a                    | 485                          | 503              | F                         |
|         |                |                   |                  |                  |                         |                         |                      |                 | R290*                    | 820                          | 580              | F                         |

\*opcional - optional

Características técnicas y constructivas sujetas a variación sin previo aviso.

- Exterior en acero inox AISI-304
- Interior en acero inox AISI-304, con aristas curvas y fondo embutido
- Puertas de apertura reversible, con sistema de cierre automático y burlete magnético (permanece abierta al superar los 90° de apertura)
- **MFC:** contrapuerta inox embutida
- **MFCV:** puerta doble cristal
- Encimera de acero inox AISI-304 con frente curvo (opcional con peto sanitario 100 mm)
- Estantes interiores GN 1/1 de alambre en acero plastificado, regulables en altura
- Pies en tubo de acero inox ajustables en altura 90 - 125 mm
- Unidad condensadora ventilada y extraíble
- Evaporador sistema tiro forzado, con recubrimiento epoxi anticorrosión
- Evaporación automática del agua de descarche
- Aislamiento de poliuretano inyectado, densidad 40 Kg/m<sup>3</sup>, cero efectos ODP y GWP
- Control digital de temperatura, descarches optimizados, alarma por alta temperatura de condensación. Eficiente gestión del consumo de energía
- Temperatura de trabajo a 38°C ambiente

We reserve the right to change specifications without prior notice.

- AISI-304 stainless steel exterior
- AISI-304 stainless steel interior, stamped bottom and rounded corners
- Doors with self closing system, blocked opening, magnetic gasket and possibility of changing the opening sense
- **MFC:** inner side of doors by stamped steel
- **MFCV:** double glazed door
- AISI-304 stainless steel worktop, with rounded front (optional with 100 mm sanitary upstand)
- GN 1/1 shelves made of plasticized steel wire, height adjustable
- AISI-304 adjustable legs, 90 to 125 mm
- Removable and fan assisted condenser unit
- Fan assisted evaporator, with epoxi anticorrosion coating.
- Automatic evaporation of defrost water
- 40 Kg/m<sup>3</sup> density polyurethane insulation, zero ODP and GWP
- Digital temperature control, optimized defrost, high-temperature condensation alarm. Efficient management of energy consumption
- Operating temperature 38°C ambient

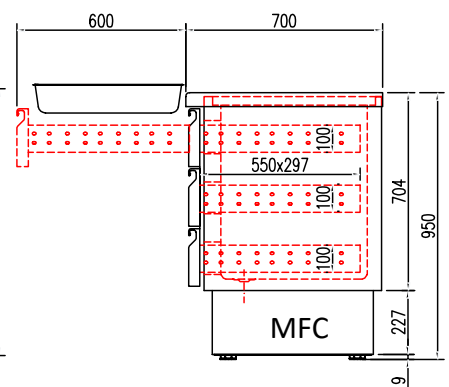
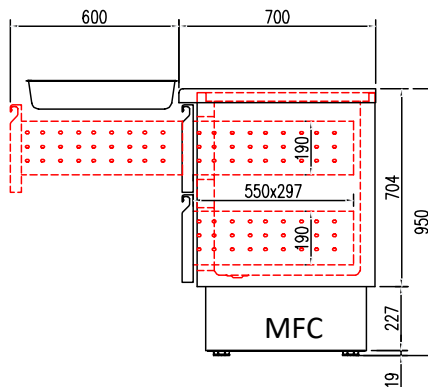
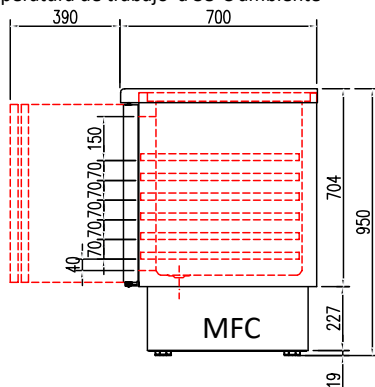

| OPCIONES                             | OPTIONS                              | €                   |
|--------------------------------------|--------------------------------------|---------------------|
| parrilla suplemento                  | extra shelf supplement               | 18 € x ud           |
| parrilla adicional GN 1/1            | GN 1/1 extra shelf                   | 23 € x ud           |
| set adicional guías GN 1/1           | GN 1/1 slides extra set              | 25 € x set          |
| cambio R134a por R290                | R134a to R290                        | + 5 %               |
| cerradura puerta                     | door lock                            | 15 € x ud           |
| encimera con peto                    | worktop with upstand                 | 0 €                 |
| set 4 ruedas                         | 4 castors set                        | 76 € x set          |
| registrador de alarmas HACCP         | HACCP alarm recorder                 | 250 € x set         |
| tropicalizado 43°C                   | tropicalized to 43°C                 | consultar - consult |
| 230v 60Hz / 115v 60Hz                | 230v 60Hz / 115v 60Hz                | consultar - consult |
| respaldo inox                        | stainless steel rear side            | consultar - consult |
| MF cajonera doble inox, autocierra   | MF double drawers set, soft clising  | 404 € x set         |
| MFC cajonera doble inox, autocierra  | MFC double drawers set, soft clising | 450 € x set         |
| MFC cajonera triple inox, autocierra | MFC triple drawers set, soft clising | 604 € x set         |

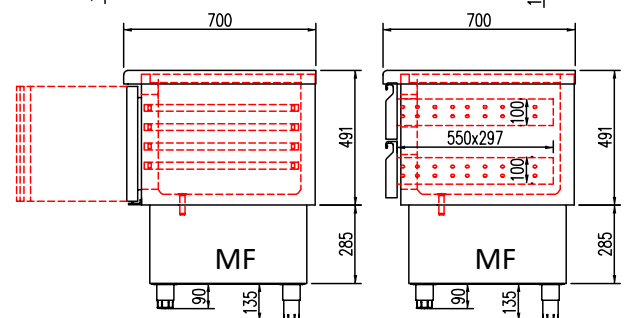
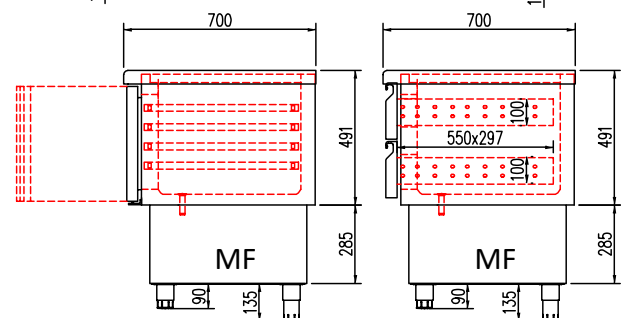



all photos must be considered as a reference - fotografías no contractuales



MFC-100  
con ruedas  
with castors



MFCV-140



MF-100

Comparativa capacidades gama MFC MRG *capacity comparison*

| mod.    | largo<br>length<br>(mm) | alto<br>height<br>(mm) | fondo<br>depth<br>(mm) | capacidad<br>capacity<br>(L) |
|---------|-------------------------|------------------------|------------------------|------------------------------|
| MFC-100 | 915                     | 950                    | 700                    | 265                          |
| MRG-150 | 1395                    | 850                    | 700                    | 265                          |
| MFC-140 | 1365                    | 950                    | 700                    | 450                          |
| MRG-200 | 1795                    | 850                    | 700                    | 450                          |



MRG-200



MFC-140



MFB-120 2.337 €



MFB-160 2.838 €



MFB-120-CC 3.154 €



MFB-160-CC 4.064 €

| mod.       | rango range °C | largo length (mm) | alto height (mm) | fondo depth (mm) | estantes shelves GN 1/1 | pares guías slides sets | volumen capacity (L) | voltaje voltage | refrigerante refrigerant | potencia frig. power W | potencia power W | CCE EEC 2015/1094 EN16825 |
|------------|----------------|-------------------|------------------|------------------|-------------------------|-------------------------|----------------------|-----------------|--------------------------|------------------------|------------------|---------------------------|
| MFB-120    | -2°C +8°C      | 1200              | 600              | 700              | 2                       | 2                       | 169                  | 230V-50Hz       | R134a                    | 304                    | 314              | D                         |
|            |                |                   |                  |                  |                         |                         |                      |                 | R600a*                   | 418                    | 249              | D                         |
| MFB-120-CC | -2°C +8°C      | 1200              | 600              | 700              | 0                       | 0                       | 169                  | 230V-50Hz       | R134a                    | 304                    | 314              | D                         |
|            |                |                   |                  |                  |                         |                         |                      |                 | R600a*                   | 418                    | 249              | D                         |
| MFB-160    | -2°C +8°C      | 1600              | 600              | 700              | 3                       | 3                       | 264                  | 230V-50Hz       | R134a                    | 560                    | 506              | F                         |
|            |                |                   |                  |                  |                         |                         |                      |                 | R600a*                   | 497                    | 428              | E                         |
| MFB-160-CC | -2°C +8°C      | 1600              | 600              | 700              | 0                       | 0                       | 264                  | 230V-50Hz       | R134a                    | 560                    | 506              | F                         |
|            |                |                   |                  |                  |                         |                         |                      |                 | R600a*                   | 497                    | 428              | E                         |

\*opcional - optional

REFRIGERATED COUNTERS • MESAS REFRIGERADAS

Características técnicas y constructivas sujetas a variación sin previo aviso.

- Exterior en acero inox AISI-304, excepto el respaldo
- Interior en acero inox AISI-304, con aristas curvas y fondo embutido
- **MFB-CC:** Cajoneras refrigeradas inox desmontables sobre guías inox telescópicas, sistema auto-cierre de serie
- Encimera de acero inox AISI-304 con frente curvo (opcional con peto sanitario 100 mm)
- Posibilidad de fabricar encimera especial a medida
- Pies en tubo de acero inox ajustables en altura 90 - 125 mm
- Unidad condensadora ventilada y extraíble
- Evaporador CENTRAL, sistema tiro forzado, con recubrimiento epoxi anticorrosión
- Evaporación automática del agua de descarche
- Aislamiento de poliuretano inyectado, densidad 40 Kg/m<sup>3</sup>, cero GWP y cero efecto ODP
- Control digital de temperatura, descarches optimizados, alarma por alta temperatura de condensación. Eficiente gestión del consumo de energía
- Temperatura de trabajo a 32°C ambiente

We reserve the right to change specifications without prior notice.

- AISI-304 stainless steel exterior, rear side galvanized panel
- AISI-304 stainless steel interior, stamped bottom and rounded corners
- **MFB-CC:** Stainless steel drawers with telescopic stainless steel slides for complete opening, self-closing system as standard
- AISI-304 stainless steel worktop, with rounded front (optional with 100 mm sanitary upstand)
- Worktop can be customized on demand
- AISI -304 adjustable legs, 90 to 125 mm
- Removable and fan assisted condenser unit
- CENTRAL Fan assisted evaporator, with epoxi anticorrosion coating.
- Automatic evaporation of defrost water
- 40 Kg/m<sup>3</sup> density polyurethane insulation, zero GWP and zero ODP effect
- Digital temperature control, optimized defrost, high-temperature condensation alarm. Efficient management of energy consumption
- Operating temperature 32°C ambient

| OPCIONES                     | OPTIONS                   | €                  |
|------------------------------|---------------------------|--------------------|
| parrilla suplemento          | extra shelf supplement    | 18 € x ud          |
| cambio R134a por R600a       | R134a to R600a            | + 0%               |
| encimera con peto            | worktop with upstand      | 0 €                |
| set 4 ruedas                 | 4 castors set             | 76 € x set         |
| set 6 ruedas                 | 6 castors set             | 117 € x set        |
| registrador de alarmas HACCP | HACCP alarm recorder      | 250 € x set        |
| respaldo inox                | stainless steel rear side | consultar- consult |
| tropicalizado 43°C           | tropicalized to 43°C      | consultar- consult |
| 230v 60Hz / 115v 60Hz        | 230v 60Hz / 115v 60Hz     | consultar- consult |

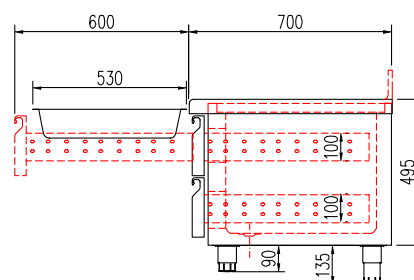

# Mesa fría GN 1/1, refrigeración BAJO COCINA modular 400 modular 400 GN 1/1 chiller counter UNDER BROILER

1

all photos must be considered as a reference - fotografías no contractuales





KBR-47 2.254 €



KBR-65 3.113 €



KBR-83 3.784 €

| mod.   | rango range °C | largo length (mm) | alto height (mm) | fondo depth (mm) | estantes shelves GN 1/1 | pares guías slides sets | volumen capacity (L) | voltaje voltage | refrigerante refrigerant | potencia frig. frig. power W | potencia power W | CCE EEC 2015/1094 EN16825 |
|--------|----------------|-------------------|------------------|------------------|-------------------------|-------------------------|----------------------|-----------------|--------------------------|------------------------------|------------------|---------------------------|
| KBR-47 | -2°C +8°C      | 1210              | 600              | 700              | 0                       | 0                       | 169                  | 230V-50Hz       | R134a                    | 304                          | 314              | D                         |
|        |                |                   |                  |                  |                         |                         |                      |                 | R290*                    | 302                          | 261              | D                         |
| KBR-65 | -2°C +8°C      | 1660              | 600              | 700              | 0                       | 0                       | 264                  | 230V-50Hz       | R134a                    | 304                          | 314              | E                         |
|        |                |                   |                  |                  |                         |                         |                      |                 | R290*                    | 507                          | 261              | D                         |
| KBR-83 | -2°C +8°C      | 2110              | 600              | 700              | 0                       | 0                       | 359                  | 230V-50Hz       | R134a                    | 304                          | 314              | E                         |
|        |                |                   |                  |                  |                         |                         |                      |                 | R290*                    | 507                          | 261              | D                         |

\*opcional - optional

Características técnicas y constructivas sujetas a variación sin previo aviso.

We reserve the right to change specifications without prior notice.

- Exterior en acero inox AISI-304, excepto el respaldo
- Interior en acero inox AISI-304, con aristas curvas y fondo embutido
- Cajoneras refrigeradas inox desmontables sobre guías inox telescópicas, sistema auto-cierre de serie
- Encimera de acero inox AISI-304 con frente curvo (opcional con peto sanitario 100 mm)
- Posibilidad de fabricar encimera especial a medida
- Pies en tubo de acero inox ajustables en altura 90 - 125 mm
- Unidad condensadora ventilada y extraíble
- Evaporador sistema tiro forzado, con recubrimiento epoxi anticorrosión
- Evaporación automática del agua de descarche
- Aislamiento de poliuretano inyectado, densidad 40 Kg/m<sup>3</sup>, cero GWP y cero efecto ODP
- Control digital de temperatura, descarches optimizados, alarma por alta temperatura de condensación. Eficiente gestión del consumo de energía
- Temperatura de trabajo a 38°C ambiente

- AISI-304 stainless steel exterior, rear side galvanized panel
- AISI-304 stainless steel interior, stamped bottom and rounded corners
- Stainless steel drawers with telescopic stainless steel slides for complete opening, self-closing system as standard
- AISI-304 stainless steel worktop, with rounded front (optional with 100 mm sanitary upstand)
- Worktop can be customized on demand
- AISI -304 adjustable legs, 90 to 125 mm
- Removable and fan assisted condenser unit
- Fan assisted evaporator, with epoxi anticorrosion coating.
- Automatic evaporation of defrost water
- 40 Kg/m<sup>3</sup> density polyurethane insulation, zero GWP and zero ODP effect
- Digital temperature control, optimized defrost, high-temperature condensation alarm. Efficient management of energy consumption
- Operating temperature 38°C ambient

| OPCIONES                     | OPTIONS                   | €                  |
|------------------------------|---------------------------|--------------------|
| encimera con peto            | worktop with upstand      | 0 €                |
| cambio R134a por R290        | R134a to R290             | + 5 %              |
| set 4 ruedas                 | 4 castors set             | 76 € x set         |
| set 6 ruedas                 | 6 castors set             | 117 € x set        |
| registrador de alarmas HACCP | HACCP alarm recorder      | 250 € x set        |
| respaldo inox                | stainless steel rear side | consultar- consult |
| tropicalizado 43°C           | tropicalized to 43°C      | consultar- consult |
| 230v 60Hz / 115v 60Hz        | 230v 60Hz / 115v 60Hz     | consultar- consult |

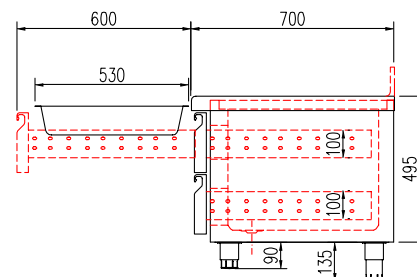

all photos must be considered as a reference - fotografías no contractuales







MFB-135 1.933 €



MFB-180 2.327 €



MFB-220 2.782 €



MFB-270 3.278 €



MFB-135 -C 2.244 €



MFB-180-C 2.838 €



MFB-220-C 3.521 €



MFB-270-C 4.137 €



MFB-135 -CC 2.652 €



MFB-180-CC 3.247 €



MFB-220-CC 3.930 €

| mod.       | rango range °C | largo length (mm) | alto height (mm) | fondo depth (mm) | estantes shelves GN 1/1 | pares guías slides sets | volumen capacity (L) | voltaje voltage | refrigerante refrigerant | potencia frig. frig. power W | potencia power W | CCE EEC 2015/1094 EN16825 |
|------------|----------------|-------------------|------------------|------------------|-------------------------|-------------------------|----------------------|-----------------|--------------------------|------------------------------|------------------|---------------------------|
| MFB-135    | -2°C +8°C      | 1345              | 600              | 700              | 2                       | 2                       | 169                  | 230V-50Hz       | R134a                    | 178                          | 207              | C                         |
|            |                |                   |                  |                  |                         |                         |                      |                 | R290*                    | 280                          | 218              | B                         |
| MFB-180    | -2°C +8°C      | 1795              | 600              | 700              | 3                       | 3                       | 264                  | 230V-50Hz       | R134a                    | 245                          | 253              | D                         |
|            |                |                   |                  |                  |                         |                         |                      |                 | R290*                    | 280                          | 218              | B                         |
| MFB-220    | -2°C +8°C      | 2245              | 600              | 700              | 4                       | 4                       | 359                  | 230V-50Hz       | R134a                    | 304                          | 293              | D                         |
|            |                |                   |                  |                  |                         |                         |                      |                 | R290*                    | 502                          | 239              | C                         |
| MFB-270    | -2°C +8°C      | 2695              | 600              | 700              | 5                       | 5                       | 454                  | 230V-50Hz       | R134a                    | 304                          | 293              | D                         |
|            |                |                   |                  |                  |                         |                         |                      |                 | R290*                    | 502                          | 239              | C                         |
| MFB-135-C  | -2°C +8°C      | 1345              | 600              | 700              | 1                       | 1                       | 169                  | 230V-50Hz       | R124a                    | 178                          | 211              | C                         |
|            |                |                   |                  |                  |                         |                         |                      |                 | R290*                    | 280                          | 218              | B                         |
| MFB-180-C  | -2°C +8°C      | 1795              | 600              | 700              | 1                       | 1                       | 264                  | 230V-50Hz       | R134a                    | 245                          | 253              | D                         |
|            |                |                   |                  |                  |                         |                         |                      |                 | R290*                    | 280                          | 218              | C                         |
| MFB-220-C  | -2°C +8°C      | 2245              | 600              | 700              | 1                       | 1                       | 359                  | 230V-50Hz       | R134a                    | 304                          | 293              | D                         |
|            |                |                   |                  |                  |                         |                         |                      |                 | R290*                    | 739                          | 410              | D                         |
| MFB-135-CC | -2°C +8°C      | 1345              | 600              | 700              | 0                       | 0                       | 169                  | 230V-50Hz       | R124a                    | 304                          | 314              | E                         |
|            |                |                   |                  |                  |                         |                         |                      |                 | R290*                    | 502                          | 277              | D                         |
| MFB-180-CC | -2°C +8°C      | 1795              | 600              | 700              | 0                       | 0                       | 264                  | 230V-50Hz       | R134a                    | 485                          | 503              | F                         |
|            |                |                   |                  |                  |                         |                         |                      |                 | R290*                    | 1004                         | 615              | F                         |
| MFB-220-CC | -2°C +8°C      | 2245              | 600              | 700              | 0                       | 0                       | 359                  | 230V-50Hz       | R134a                    | 485                          | 503              | F                         |
|            |                |                   |                  |                  |                         |                         |                      |                 | R290*                    | 1004                         | 615              | F                         |

\*opcional - optional

Características técnicas y constructivas sujetas a variación sin previo aviso.

- MFB dotación de puertas
- MFB-C dotación de cajoneras dobles + una puerta
- MFB-CC dotación de cajoneras dobles + evaporadores centrales

- Exterior en acero inox AISI-304, excepto el respaldo
- Interior en acero inox AISI-304, con aristas curvas y fondo embutido
- Puertas de apertura reversible, con sistema de cierre automático y burlete magnético (permanece abierta al superar los 90° de apertura)
- Cajoneras refrigeradas inox desmontables sobre guías inox telescópicas, sistema auto-cierre de serie
- Encimera de acero inox AISI-304 con frente curvo (opcional con peto sanitario 100 mm)
- Estantes interiores GN 1/1 de alambre en acero plastificado, regulables en altura
- Pies en tubo de acero inox ajustables en altura 90 - 125 mm
- Unidad condensadora ventilada y extraíble
- Evaporador sistema tiro forzado, con recubrimiento epoxi anticorrosión
- Evaporación automática del agua de descarche
- Aislamiento de poliuretano inyectado, densidad 40 Kg/m<sup>3</sup>, cero efectos ODP y GWP
- Control digital de temperatura, descarches optimizados, alarma por alta temperatura de condensación. Eficiente gestión del consumo de energía
- Temperatura de trabajo a 38°C ambiente

We reserve the right to change specifications without prior notice.

- MFB doors as standard
- MFB-C double drawers sets + one dor as standard
- MFB-CC double drawers sets + evaporators between drawers

- AISI-304 stainless steel exterior, rear side galvanized panel
- AISI-304 stainless steel interior, stamped bottom and rounded corners
- Doors with self closing system, blocked opening, magnetic gasket and possibility of changing the opening sense
- Stainless steel drawers with telescopic stainless steel slides for complete opening, soft-closing system as standard
- AISI-304 stainless steel worktop, with rounded front (optional with 100 mm sanitary upstand)
- GN 1/1 shelves made of plasticized steel wire, height adjustable
- AISI -304 adjustable legs, 90 to 125 mm
- Removable and fan assisted condenser unit
- Fan assisted evaporator, with epoxi anticorrosion coating.
- Automatic evaporation of defrost water
- 40 Kg/m<sup>3</sup> density polyurethane insulation, zero ODP and GWP
- Digital temperature control, optimized defrost, high-temperature condensation alarm. Efficient management of energy consumption
- Operating temperature 38°C ambient

| OPCIONES                     | OPTIONS                   | €                   |
|------------------------------|---------------------------|---------------------|
| parrilla suplemento          | extra shelf supplement    | 18 € x ud           |
| parrilla adicional GN 1/1    | GN 1/1 extra shelf        | 23 € x ud           |
| set adicional guías GN 1/1   | GN 1/1 slides extra set   | 25 € x set          |
| cambio R134a por R290        | R134a to R290             | + 5 %               |
| cerradura puerta inox        | solid door lock           | 15 € x ud           |
| motor lado izquierdo         | left side engine          | 56 €                |
| encimera con peto            | worktop with upstand      | 0 €                 |
| set 4 ruedas                 | 4 castors set             | 76 € x set          |
| set 6 ruedas                 | 6 castors set             | 117 € x set         |
| registrador de alarmas HACCP | HACCP alarm recorder      | 250 € x set         |
| pre-instalación              | remote compressor         | consultar - consult |
| respaldo inox                | stainless steel rear side | consultar - consult |
| tropicalizado 43°C           | tropicalized to 43°C      | consultar - consult |
| 230v 60Hz / 115v 60Hz        | 230v 60Hz / 115v 60Hz     | consultar - consult |

Pre-instalación opcional  
Optional remote compressor



all photos must be considered as a reference - fotografías no contractuales



600 mm



MFB-180-CC



puerta  
door

MFB-220-C

GN 1/1 - 100

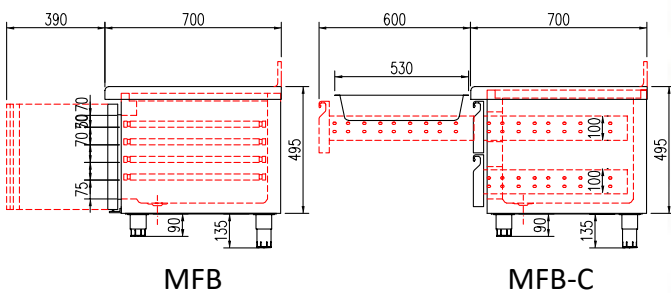

MFB

MFB-C





|         |         |
|---------|---------|
| MRP-150 | 2.223 € |
| MCP-150 | 2.755 € |



|         |         |
|---------|---------|
| MRP-200 | 2.657 € |
| MCP-200 | 3.228 € |



|         |         |
|---------|---------|
| MRP-250 | 3.206 € |
|---------|---------|



|          |         |
|----------|---------|
| MRPV-150 | 2.540 € |
| MCPV-150 | 3.088 € |



|          |         |
|----------|---------|
| MRPV-200 | 3.120 € |
| MCPV-200 | 3.706 € |



|          |         |
|----------|---------|
| MRPV-250 | 3.780 € |
| MCPV-250 | 4.127 € |

| mod.     | rango range °C | largo length (mm) | alto height (mm) | fondo depth (mm) | estantes shelves 40x60 | pares guías slides sets | volumen capacity (L) | voltaje voltage | refrigerante refrigerant | potencia frig. frig. power W | potencia power W | CCE EEC 2015/1094 EN16825 |
|----------|----------------|-------------------|------------------|------------------|------------------------|-------------------------|----------------------|-----------------|--------------------------|------------------------------|------------------|---------------------------|
| MRP-150  | -2°C +8°C      | 1495              | 850              | 800              | 0                      | 10                      | 362                  | 230V-50Hz       | R134a                    | 178                          | 211              | C                         |
|          |                |                   |                  |                  |                        |                         |                      |                 | R290*                    | 280                          | 218              | B                         |
| MRP-200  | -2°C +8°C      | 2020              | 850              | 800              | 0                      | 15                      | 562                  | 230V-50Hz       | R134a                    | 245                          | 249              | D                         |
|          |                |                   |                  |                  |                        |                         |                      |                 | R290*                    | 280                          | 220              | C                         |
| MRP-250  | -2°C +8°C      | 2545              | 850              | 800              | 0                      | 20                      | 761                  | 230V-50Hz       | R134a                    | 304                          | 289              | C                         |
|          |                |                   |                  |                  |                        |                         |                      |                 | R290*                    | 739                          | 412              | B                         |
| MRPV-150 | -2°C +8°C      | 1495              | 850              | 800              | 0                      | 10                      | 362                  | 230V-50Hz       | R134a                    | 304                          | 298              | -                         |
|          |                |                   |                  |                  |                        |                         |                      |                 | R290*                    | 280                          | 221              | -                         |
| MRPV-200 | -2°C +8°C      | 2020              | 850              | 800              | 0                      | 15                      | 562                  | 230V-50Hz       | R134a                    | 304                          | 302              | -                         |
|          |                |                   |                  |                  |                        |                         |                      |                 | R290*                    | 502                          | 257              | -                         |
| MRPV-250 | -2°C +8°C      | 2545              | 850              | 800              | 0                      | 20                      | 761                  | 230V-50Hz       | R134a                    | 485                          | 446              | -                         |
|          |                |                   |                  |                  |                        |                         |                      |                 | R290*                    | 739                          | 410              | -                         |
| MCP-150  | -20°C -15°C    | 1495              | 850              | 800              | 0                      | 10                      | 362                  | 230V-50Hz       | R290                     | 606                          | 535              | F                         |
|          |                |                   |                  |                  |                        |                         |                      |                 | R452A*                   | 353                          | 552              | F                         |
| MCP-200  | -20°C -15°C    | 2020              | 850              | 800              | 0                      | 15                      | 562                  | 230V-50Hz       | R290                     | 606                          | 556              | F                         |
|          |                |                   |                  |                  |                        |                         |                      |                 | R452A*                   | 452                          | 610              | E                         |
| MCPV-150 | -20°C -15°C    | 1495              | 850              | 800              | 0                      | 10                      | 362                  | 230V-50Hz       | R290                     | 606                          | 544              | -                         |
|          |                |                   |                  |                  |                        |                         |                      |                 | R452A*                   | 353                          | 518              | -                         |
| MCPV-200 | -20°C -15°C    | 2020              | 850              | 800              | 0                      | 15                      | 562                  | 230V-50Hz       | R290                     | 606                          | 569              | -                         |
|          |                |                   |                  |                  |                        |                         |                      |                 | R452A*                   | 452                          | 681              | -                         |

\*opcional - optional

Características técnicas y constructivas sujetas a variación sin previo aviso.

We reserve the right to change specifications without prior notice.

- Exterior en acero inox AISI-304, excepto el respaldo
- Interior en acero inox AISI-304, con aristas curvas y fondo embutido
- Puertas de apertura reversible, con sistema de cierre automático y burlete magnético (permanece abierta al superar los 90° de apertura)
- Contrapuerta inox embutida
- Encimera de acero inox AISI-304 con frente curvo (opcional con peto)
- Pies en tubo de acero inox ajustables en altura 125 - 200 mm
- Unidad condensadora ventilada y extraíble
- Evaporador sistema tiro forzado, con recubrimiento epoxi anticorrosión
- Evaporación automática del agua de descarche
- Aislamiento de poliuretano inyectado, densidad 40 Kg/m<sup>3</sup>, cero efectos ODP y GWP
- Control digital de temperatura, descarches optimizados, alarma por alta temperatura de condensación. Eficiente gestión del consumo de energía
- Temperatura de trabajo: 38°C ambiente

- AISI-304 stainless steel exterior, rear side galvanized panel
- AISI-304 stainless steel interior, stamped bottom and rounded corners
- Doors with self closing system, blocked opening, magnetic gasket and possibility of changing the opening sense
- Inner side of doors by stamped steel
- AISI-304 stainless steel worktop, with rounded front (optional with upstand)
- AISI -304 adjustable legs, 125 to 200 mm
- Removable and fan assisted condenser unit
- Fan assisted evaporator, with epoxi anticorrosion coating.
- Automatic evaporation of defrost water
- 40 Kg/m<sup>3</sup> density polyurethane insulation, zero ODP and GWP
- Digital temperature control, optimized defrost, high-temperature condensation alarm. Efficient management of energy consumption
- Operating temperature: 38°C ambient

| OPCIONES                     | OPTIONS                   | €                   |
|------------------------------|---------------------------|---------------------|
| parrilla suplemento          | extra shelf supplement    | 24 € x ud           |
| parrilla 60x40               | 60x40 shelf               | 24 € x ud           |
| set adicional guías 60x40    | 60x40 slides extra set    | 19 € x set          |
| cambio R134a por R290        | R134a to R290             | + 5 %               |
| cambio R290 por R452A        | R290 to R452A             | 0 %                 |
| cerradura puerta inox        | solid door lock           | 15 € x ud           |
| cerradura puerta cristal     | glass door lock           | 46 € x ud           |
| motor lado izquierdo         | left side engine          | 56 €                |
| encimera con peto            | worktop with upstand      | 0 €                 |
| set 4 ruedas perez           | 4 castors set             | 76 € x set          |
| set 6 ruedas                 | 6 castors set             | 117 € x set         |
| registrador de alarmas HACCP | HACCP alarm recorder      | 250 € x set         |
| 230v 60Hz / 115v 60Hz        | 230v 60Hz / 115v 60Hz     | consultar- consult  |
| tropicalizado 43°C           | tropicalized to 43°C      | consultar- consult  |
| pre-instalación              | remote compressor         | consultar - consult |
| respaldo inox                | stainless steel rear side | consultar- consult  |
| encimera de granito          | granite worktop           | consultar- consult  |

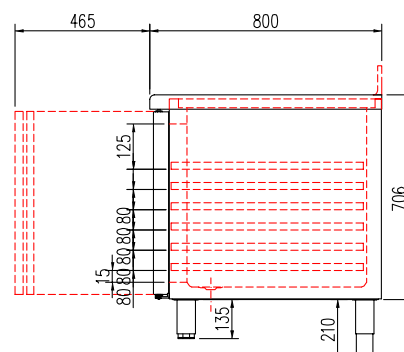

all photos must be considered as a reference - fotografías no contractuales

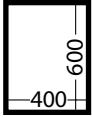

**MRPV-250**  
dotación parillas extra  
with extra shelves



**MRP-250**

Encimera granito opcional  
*Optional granite worktop*

Pre-instalación opcional  
*Optional remote compressor*

