

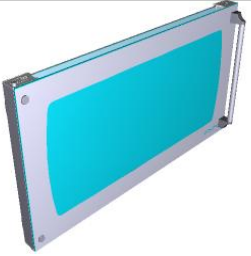



Código del conjunto	Descripción del conjunto	Imagen del conjunto
ASM1447A/0.D00	Instalación eléctrica	
ASM0028C/0.D00	Puerta	
ASM1441C/0.D00	Cámara de cocción	
ASM1444A/0.D03	Cobertura exterior	

ASM1447A/0.D00 - Instalación eléctrica

REVERSO

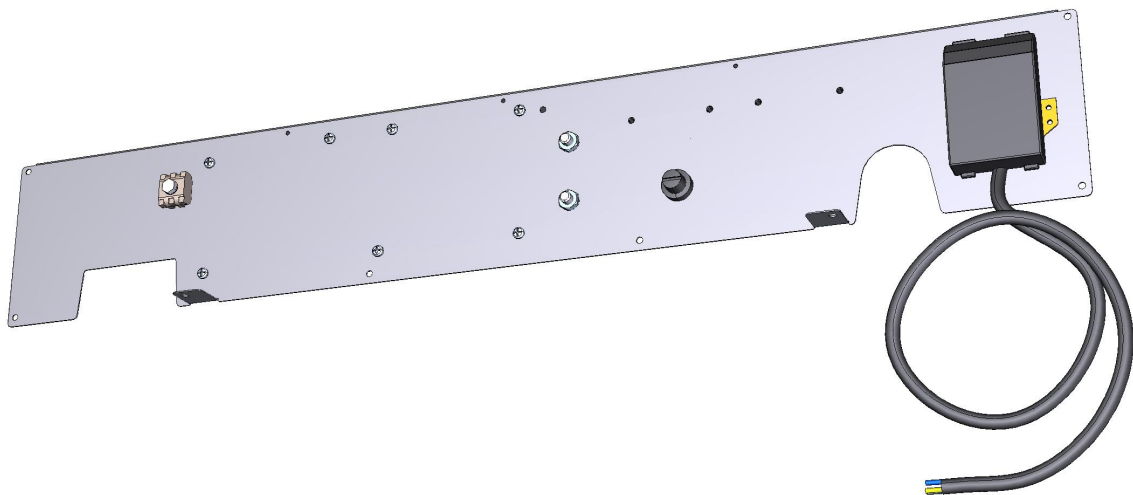

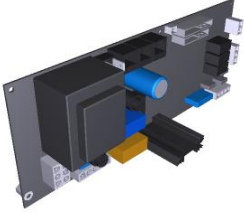
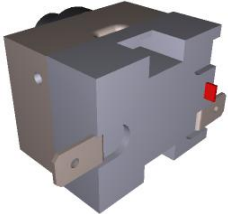
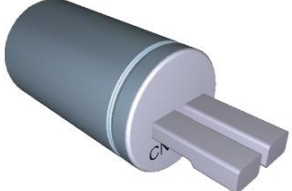
COMPONENTE			REPUESTO																										
Código	Descripción	Imagen	Código	Descripción	Lista de componentes																								
PE2019A	TARJETA POTENCIA LINE MISS TOP/MATIC		KPE2019A	KIT TARJETA POTENCIA LINEMISS TOP/MATI	<table border="1"> <thead> <tr> <th>Código</th> <th>Descripción</th> <th>Cant.</th> <th>UdM</th> </tr> </thead> <tbody> <tr> <td>PE2019A0</td> <td>TARJETA POTENCIA LINE MISS TOP/MATIC</td> <td>1</td> <td>PZ</td> </tr> <tr> <td>V11850A0</td> <td>TORNILLOS DE FIJACION NIQUELADOS M4X6</td> <td>7</td> <td>PZ</td> </tr> <tr> <td>VM1745A0</td> <td>SOPORTE PARA TARJET</td> <td>6</td> <td>PZ</td> </tr> <tr> <td>VM2147A0</td> <td></td> <td>1</td> <td>PZ</td> </tr> </tbody> </table>	Código	Descripción	Cant.	UdM	PE2019A0	TARJETA POTENCIA LINE MISS TOP/MATIC	1	PZ	V11850A0	TORNILLOS DE FIJACION NIQUELADOS M4X6	7	PZ	VM1745A0	SOPORTE PARA TARJET	6	PZ	VM2147A0		1	PZ				
Código	Descripción	Cant.	UdM																										
PE2019A0	TARJETA POTENCIA LINE MISS TOP/MATIC	1	PZ																										
V11850A0	TORNILLOS DE FIJACION NIQUELADOS M4X6	7	PZ																										
VM1745A0	SOPORTE PARA TARJET	6	PZ																										
VM2147A0		1	PZ																										
CE1130A	CABLE 5X1,5MMQ H07RN-F L=1,5M + MORS.K1/		KCE1130A	KIT CABLE 5X1,5MMQ L=1,5M+TERMINAL CONEX	<table border="1"> <thead> <tr> <th>Código</th> <th>Descripción</th> <th>Cant.</th> <th>UdM</th> </tr> </thead> <tbody> <tr> <td>CE1130A1</td> <td>CABLE 5X1,5MMQ H07RN-F L=1,5M + MORS.K1/</td> <td>1</td> <td>PZ</td> </tr> </tbody> </table>	Código	Descripción	Cant.	UdM	CE1130A1	CABLE 5X1,5MMQ H07RN-F L=1,5M + MORS.K1/	1	PZ																
Código	Descripción	Cant.	UdM																										
CE1130A1	CABLE 5X1,5MMQ H07RN-F L=1,5M + MORS.K1/	1	PZ																										
TR1136A	TERMOSTATO SEGURIDAD 330 °C		KTR1136A	KIT TERMOSTATO DE SEGUR. UNIPOL TR1136A	<table border="1"> <thead> <tr> <th>Código</th> <th>Descripción</th> <th>Cant.</th> <th>UdM</th> </tr> </thead> <tbody> <tr> <td>0H7030A0</td> <td>TAPA ENTRADA BULBO</td> <td>1</td> <td>PZ</td> </tr> <tr> <td>GN1531A0</td> <td>GOMA SONDA</td> <td>1</td> <td>PZ</td> </tr> <tr> <td>SL1045A0</td> <td>SILICONA ANTRACITA S53 SP-5007 80ML</td> <td>1</td> <td>PZ</td> </tr> <tr> <td>TR1136A0</td> <td>TERMOSTATO SEGURIDAD 330 °C</td> <td>1</td> <td>PZ</td> </tr> <tr> <td>V11220A1</td> <td>VITE AUTOFIL. 4.2X12 TCB MARUTEX</td> <td>3</td> <td>PZ</td> </tr> </tbody> </table>	Código	Descripción	Cant.	UdM	0H7030A0	TAPA ENTRADA BULBO	1	PZ	GN1531A0	GOMA SONDA	1	PZ	SL1045A0	SILICONA ANTRACITA S53 SP-5007 80ML	1	PZ	TR1136A0	TERMOSTATO SEGURIDAD 330 °C	1	PZ	V11220A1	VITE AUTOFIL. 4.2X12 TCB MARUTEX	3	PZ
Código	Descripción	Cant.	UdM																										
0H7030A0	TAPA ENTRADA BULBO	1	PZ																										
GN1531A0	GOMA SONDA	1	PZ																										
SL1045A0	SILICONA ANTRACITA S53 SP-5007 80ML	1	PZ																										
TR1136A0	TERMOSTATO SEGURIDAD 330 °C	1	PZ																										
V11220A1	VITE AUTOFIL. 4.2X12 TCB MARUTEX	3	PZ																										
CN1003A	CONDENSADOR 6,3 UF		KCN1003A	KIT CONDENSADOR MOTOR	<table border="1"> <thead> <tr> <th>Código</th> <th>Descripción</th> <th>Cant.</th> <th>UdM</th> </tr> </thead> <tbody> <tr> <td>CN1003A0</td> <td>CONDENSADO R 6,3 UF</td> <td>1</td> <td>PZ</td> </tr> <tr> <td>V11931A0</td> <td></td> <td>1</td> <td>PZ</td> </tr> <tr> <td>V11932A0</td> <td></td> <td>1</td> <td>PZ</td> </tr> </tbody> </table>	Código	Descripción	Cant.	UdM	CN1003A0	CONDENSADO R 6,3 UF	1	PZ	V11931A0		1	PZ	V11932A0		1	PZ								
Código	Descripción	Cant.	UdM																										
CN1003A0	CONDENSADO R 6,3 UF	1	PZ																										
V11931A0		1	PZ																										
V11932A0		1	PZ																										

COMPONENTE			REPUESTO															
Código	Descripción	Imagen	Código	Descripción	Lista de componentes													
VE1115A	MINICONTACTOR CUADRIPOlar 20 DE 230V		KVE1115A	KIT MINICONTACTOR CUADRIPOlar 20A 230V	<table border="1"> <thead> <tr> <th>Código</th> <th>Descripción</th> <th>Cant.</th> <th>UdM</th> </tr> </thead> <tbody> <tr> <td>VE1115A0</td> <td>MINICONTACTOR CUADRIPOlar 20 DE 230V</td> <td>1</td> <td>PZ</td> </tr> <tr> <td>VM1075A1</td> <td>CLIP SUJECION PARA TELERUPTOR ES</td> <td>4</td> <td>PZ</td> </tr> </tbody> </table>	Código	Descripción	Cant.	UdM	VE1115A0	MINICONTACTOR CUADRIPOlar 20 DE 230V	1	PZ	VM1075A1	CLIP SUJECION PARA TELERUPTOR ES	4	PZ	
Código	Descripción	Cant.	UdM															
VE1115A0	MINICONTACTOR CUADRIPOlar 20 DE 230V	1	PZ															
VM1075A1	CLIP SUJECION PARA TELERUPTOR ES	4	PZ															
VM1056A			VM1056A0															
VM1750A	PLACA TERMINAL		KVM1750A		<table border="1"> <thead> <tr> <th>Código</th> <th>Descripción</th> <th>Cant.</th> <th>UdM</th> </tr> </thead> <tbody> <tr> <td>VM1750A0</td> <td>PLACA TERMINAL</td> <td>1</td> <td>PZ</td> </tr> </tbody> </table>	Código	Descripción	Cant.	UdM	VM1750A0	PLACA TERMINAL	1	PZ					
Código	Descripción	Cant.	UdM															
VM1750A0	PLACA TERMINAL	1	PZ															
0H6601A			0H6601A1															

ASM0028C/0.D00 - Puerta

ANVERSO

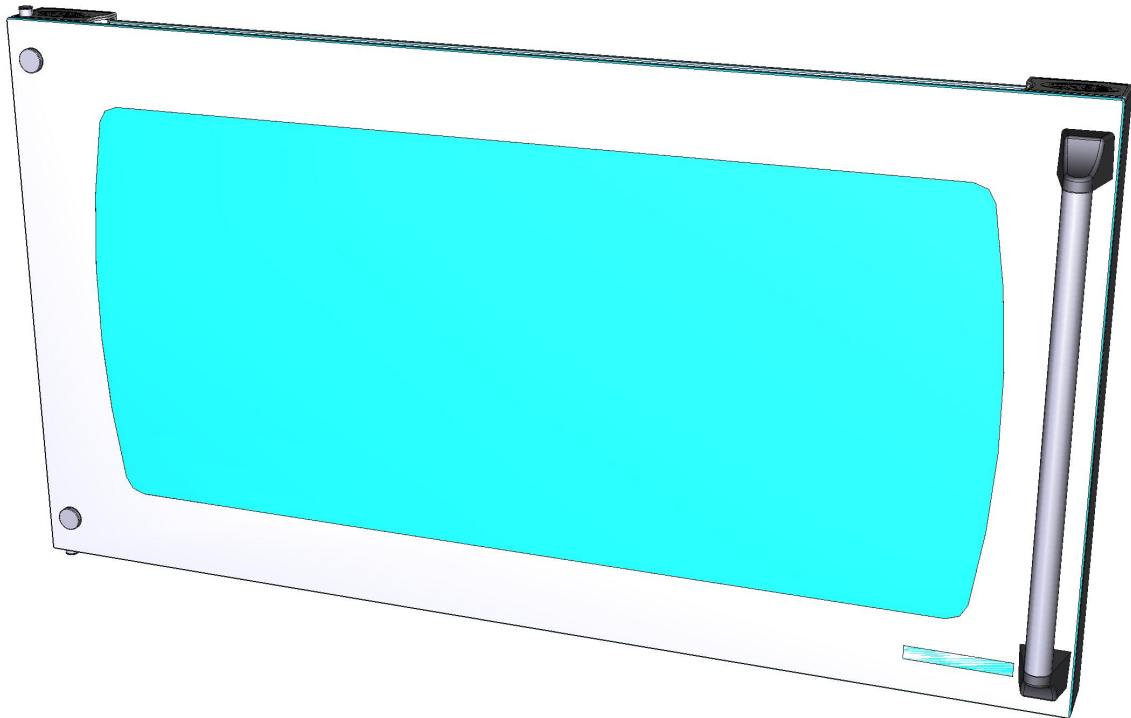

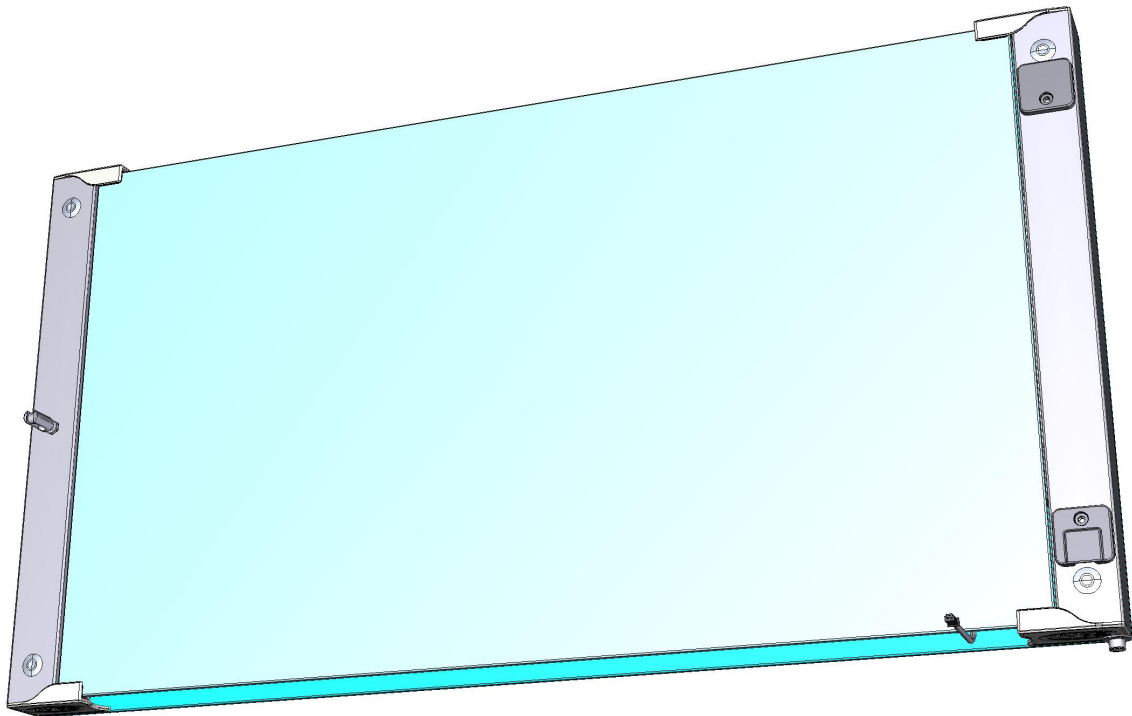

ASM0028C/0.D00 - Puerta

REVERSO



COMPONENTE			REPUESTO																																																																																							
Código	Descripción	Imagen	Código	Descripción	Lista de componentes																																																																																					
VT1074A	CRISTAL EXT. 798X424X5 NEGRO XF/XFT199		KVT1074A	KIT CRISTAL EXTERNO LINEMISS XFT199	<table border="1"> <thead> <tr> <th>Código</th> <th>Descripción</th> <th>Cant.</th> <th>UdM</th> </tr> </thead> <tbody> <tr> <td>0H2626A0</td> <td>COLUMNA DER/IZQ LM XF-XFT199</td> <td>2</td> <td>PZ</td> </tr> <tr> <td>GN1265A0</td> <td>GOMA CRISTAL INTERIOR</td> <td>4</td> <td>PZ</td> </tr> <tr> <td>IP1385A1</td> <td></td> <td>1.500</td> <td>M</td> </tr> <tr> <td>SL1050A1</td> <td>CINTA BIADHESIVA 3 METROS TRANSFER VH</td> <td>0.820</td> <td>M</td> </tr> <tr> <td>SL1170A1</td> <td>SILICONA ANTRACITA S53 CARTUCHO 310ML</td> <td>73</td> <td>ML</td> </tr> <tr> <td>VI1728A0</td> <td></td> <td>2</td> <td>PZ</td> </tr> <tr> <td>VM1025A0</td> <td>TAPON NILON PA66 V2 GRIS Ø16</td> <td>4</td> <td>PZ</td> </tr> <tr> <td>VM1059A1</td> <td></td> <td>1.500</td> <td>M</td> </tr> <tr> <td>VT1074A0</td> <td>CRISTAL EXT. 798X424X5 NEGRO XF/XFT199</td> <td>1</td> <td>PZ</td> </tr> </tbody> </table>	Código	Descripción	Cant.	UdM	0H2626A0	COLUMNA DER/IZQ LM XF-XFT199	2	PZ	GN1265A0	GOMA CRISTAL INTERIOR	4	PZ	IP1385A1		1.500	M	SL1050A1	CINTA BIADHESIVA 3 METROS TRANSFER VH	0.820	M	SL1170A1	SILICONA ANTRACITA S53 CARTUCHO 310ML	73	ML	VI1728A0		2	PZ	VM1025A0	TAPON NILON PA66 V2 GRIS Ø16	4	PZ	VM1059A1		1.500	M	VT1074A0	CRISTAL EXT. 798X424X5 NEGRO XF/XFT199	1	PZ	<table border="1"> <thead> <tr> <th>Código</th> <th>Descripción</th> <th>Cant.</th> <th>UdM</th> </tr> </thead> <tbody> <tr> <td>GN1265A0</td> <td>GOMA CRISTAL INTERIOR</td> <td>4</td> <td>PZ</td> </tr> <tr> <td>IP1385A1</td> <td></td> <td>0.980</td> <td>M</td> </tr> <tr> <td>IP1508A0</td> <td></td> <td>1.360</td> <td>PZ</td> </tr> <tr> <td>SL1050A1</td> <td>CINTA BIADHESIVA 3 METROS TRANSFER VH</td> <td>0.820</td> <td>M</td> </tr> <tr> <td>TB1224B0</td> <td></td> <td>1</td> <td>PZ</td> </tr> <tr> <td>TB3084A0</td> <td></td> <td>1</td> <td>PZ</td> </tr> <tr> <td>VI1716A0</td> <td></td> <td>4</td> <td>PZ</td> </tr> <tr> <td>VM1025A0</td> <td>TAPON NILON PA66 V2 GRIS Ø16</td> <td>4</td> <td>PZ</td> </tr> <tr> <td>VM1059A1</td> <td></td> <td>1.500</td> <td>M</td> </tr> <tr> <td>VT1074A0</td> <td>CRISTAL EXT. 798X424X5 NEGRO XF/XFT199</td> <td>1</td> <td>PZ</td> </tr> </tbody> </table>	Código	Descripción	Cant.	UdM	GN1265A0	GOMA CRISTAL INTERIOR	4	PZ	IP1385A1		0.980	M	IP1508A0		1.360	PZ	SL1050A1	CINTA BIADHESIVA 3 METROS TRANSFER VH	0.820	M	TB1224B0		1	PZ	TB3084A0		1	PZ	VI1716A0		4	PZ	VM1025A0	TAPON NILON PA66 V2 GRIS Ø16	4	PZ	VM1059A1		1.500	M	VT1074A0	CRISTAL EXT. 798X424X5 NEGRO XF/XFT199	1	PZ
			Código	Descripción	Cant.	UdM																																																																																				
			0H2626A0	COLUMNA DER/IZQ LM XF-XFT199	2	PZ																																																																																				
GN1265A0	GOMA CRISTAL INTERIOR	4	PZ																																																																																							
IP1385A1		1.500	M																																																																																							
SL1050A1	CINTA BIADHESIVA 3 METROS TRANSFER VH	0.820	M																																																																																							
SL1170A1	SILICONA ANTRACITA S53 CARTUCHO 310ML	73	ML																																																																																							
VI1728A0		2	PZ																																																																																							
VM1025A0	TAPON NILON PA66 V2 GRIS Ø16	4	PZ																																																																																							
VM1059A1		1.500	M																																																																																							
VT1074A0	CRISTAL EXT. 798X424X5 NEGRO XF/XFT199	1	PZ																																																																																							
Código	Descripción	Cant.	UdM																																																																																							
GN1265A0	GOMA CRISTAL INTERIOR	4	PZ																																																																																							
IP1385A1		0.980	M																																																																																							
IP1508A0		1.360	PZ																																																																																							
SL1050A1	CINTA BIADHESIVA 3 METROS TRANSFER VH	0.820	M																																																																																							
TB1224B0		1	PZ																																																																																							
TB3084A0		1	PZ																																																																																							
VI1716A0		4	PZ																																																																																							
VM1025A0	TAPON NILON PA66 V2 GRIS Ø16	4	PZ																																																																																							
VM1059A1		1.500	M																																																																																							
VT1074A0	CRISTAL EXT. 798X424X5 NEGRO XF/XFT199	1	PZ																																																																																							
			KVT0001AR	KIT PUERTA EXTERNA ROSSELLA MAGNETIC R	<table border="1"> <thead> <tr> <th>Código</th> <th>Descripción</th> <th>Cant.</th> <th>UdM</th> </tr> </thead> <tbody> <tr> <td>GN1265A0</td> <td>GOMA CRISTAL INTERIOR</td> <td>4</td> <td>PZ</td> </tr> <tr> <td>IP1385A1</td> <td></td> <td>0.980</td> <td>M</td> </tr> <tr> <td>IP1508A0</td> <td></td> <td>1.360</td> <td>PZ</td> </tr> <tr> <td>SL1050A1</td> <td>CINTA BIADHESIVA 3 METROS TRANSFER VH</td> <td>0.820</td> <td>M</td> </tr> <tr> <td>TB1224B0</td> <td></td> <td>1</td> <td>PZ</td> </tr> <tr> <td>TB3084A0</td> <td></td> <td>1</td> <td>PZ</td> </tr> <tr> <td>VI1716A0</td> <td></td> <td>4</td> <td>PZ</td> </tr> <tr> <td>VM1025A0</td> <td>TAPON NILON PA66 V2 GRIS Ø16</td> <td>4</td> <td>PZ</td> </tr> <tr> <td>VM1059A1</td> <td></td> <td>1.500</td> <td>M</td> </tr> <tr> <td>VT1074A0</td> <td>CRISTAL EXT. 798X424X5 NEGRO XF/XFT199</td> <td>1</td> <td>PZ</td> </tr> </tbody> </table>	Código	Descripción	Cant.	UdM	GN1265A0	GOMA CRISTAL INTERIOR	4	PZ	IP1385A1		0.980	M	IP1508A0		1.360	PZ	SL1050A1	CINTA BIADHESIVA 3 METROS TRANSFER VH	0.820	M	TB1224B0		1	PZ	TB3084A0		1	PZ	VI1716A0		4	PZ	VM1025A0	TAPON NILON PA66 V2 GRIS Ø16	4	PZ	VM1059A1		1.500	M	VT1074A0	CRISTAL EXT. 798X424X5 NEGRO XF/XFT199	1	PZ																																									
Código	Descripción	Cant.	UdM																																																																																							
GN1265A0	GOMA CRISTAL INTERIOR	4	PZ																																																																																							
IP1385A1		0.980	M																																																																																							
IP1508A0		1.360	PZ																																																																																							
SL1050A1	CINTA BIADHESIVA 3 METROS TRANSFER VH	0.820	M																																																																																							
TB1224B0		1	PZ																																																																																							
TB3084A0		1	PZ																																																																																							
VI1716A0		4	PZ																																																																																							
VM1025A0	TAPON NILON PA66 V2 GRIS Ø16	4	PZ																																																																																							
VM1059A1		1.500	M																																																																																							
VT1074A0	CRISTAL EXT. 798X424X5 NEGRO XF/XFT199	1	PZ																																																																																							
			KVT0001AL	KIT PUERTA EXTERNA ROSSELLA MAGNETIC L	<table border="1"> <thead> <tr> <th>Código</th> <th>Descripción</th> <th>Cant.</th> <th>UdM</th> </tr> </thead> <tbody> <tr> <td>GN1265A0</td> <td>GOMA CRISTAL INTERIOR</td> <td>4</td> <td>PZ</td> </tr> <tr> <td>IP1385A1</td> <td></td> <td>0.980</td> <td>M</td> </tr> <tr> <td>IP1508A0</td> <td></td> <td>1.360</td> <td>PZ</td> </tr> </tbody> </table>	Código	Descripción	Cant.	UdM	GN1265A0	GOMA CRISTAL INTERIOR	4	PZ	IP1385A1		0.980	M	IP1508A0		1.360	PZ																																																																					
Código	Descripción	Cant.	UdM																																																																																							
GN1265A0	GOMA CRISTAL INTERIOR	4	PZ																																																																																							
IP1385A1		0.980	M																																																																																							
IP1508A0		1.360	PZ																																																																																							





COMPONENTE			REPUESTO																																										
Código	Descripción	Imagen	Código	Descripción	Lista de componentes																																								
VT1074A	CRISTAL EXT. 798X424X5 NEGRO XF/XFT199		KVT0001AL	KIT PUERTA EXTERNA ROSSELLA MAGNETIC L	<table border="1"> <thead> <tr> <th>Código</th> <th>Descripción</th> <th>Cant.</th> <th>UdM</th> </tr> </thead> <tbody> <tr> <td>SL1050A1</td> <td>CINTA BIADHESIVA 3 METROS TRANSFER VH</td> <td>0.820</td> <td>M</td> </tr> <tr> <td>TB1224B0</td> <td></td> <td>1</td> <td>PZ</td> </tr> <tr> <td>TB3084A0</td> <td></td> <td>1</td> <td>PZ</td> </tr> <tr> <td>VI1716A0</td> <td></td> <td>4</td> <td>PZ</td> </tr> <tr> <td>VM1025A0</td> <td>TAPON NILON PA66 V2 GRIS Ø16</td> <td>4</td> <td>PZ</td> </tr> <tr> <td>VM1059A1</td> <td></td> <td>1.500</td> <td>M</td> </tr> <tr> <td>VT1074A0</td> <td>CRISTAL EXT. 798X424X5 NEGRO XF/XFT199</td> <td>1</td> <td>PZ</td> </tr> </tbody> </table>	Código	Descripción	Cant.	UdM	SL1050A1	CINTA BIADHESIVA 3 METROS TRANSFER VH	0.820	M	TB1224B0		1	PZ	TB3084A0		1	PZ	VI1716A0		4	PZ	VM1025A0	TAPON NILON PA66 V2 GRIS Ø16	4	PZ	VM1059A1		1.500	M	VT1074A0	CRISTAL EXT. 798X424X5 NEGRO XF/XFT199	1	PZ								
			Código		Descripción	Cant.	UdM																																						
			SL1050A1		CINTA BIADHESIVA 3 METROS TRANSFER VH	0.820	M																																						
TB1224B0		1	PZ																																										
TB3084A0		1	PZ																																										
VI1716A0		4	PZ																																										
VM1025A0	TAPON NILON PA66 V2 GRIS Ø16	4	PZ																																										
VM1059A1		1.500	M																																										
VT1074A0	CRISTAL EXT. 798X424X5 NEGRO XF/XFT199	1	PZ																																										
KVT0001A	<table border="1"> <thead> <tr> <th>Código</th> <th>Descripción</th> <th>Cant.</th> <th>UdM</th> </tr> </thead> <tbody> <tr> <td>GN1265A0</td> <td>GOMA CRISTAL INTERIOR</td> <td>4</td> <td>PZ</td> </tr> <tr> <td>IP1385A1</td> <td></td> <td>0.980</td> <td>M</td> </tr> <tr> <td>IP1508A0</td> <td></td> <td>1.360</td> <td>PZ</td> </tr> <tr> <td>SL1050A1</td> <td>CINTA BIADHESIVA 3 METROS TRANSFER VH</td> <td>0.820</td> <td>M</td> </tr> <tr> <td>TB1224B0</td> <td></td> <td>2</td> <td>PZ</td> </tr> <tr> <td>VI1716A0</td> <td></td> <td>4</td> <td>PZ</td> </tr> <tr> <td>VM1025A0</td> <td>TAPON NILON PA66 V2 GRIS Ø16</td> <td>4</td> <td>PZ</td> </tr> <tr> <td>VM1059A1</td> <td></td> <td>1.500</td> <td>M</td> </tr> <tr> <td>VT1074A0</td> <td>CRISTAL EXT. 798X424X5 NEGRO XF/XFT199</td> <td>1</td> <td>PZ</td> </tr> </tbody> </table>	Código	Descripción	Cant.	UdM	GN1265A0	GOMA CRISTAL INTERIOR	4	PZ	IP1385A1		0.980	M	IP1508A0		1.360	PZ	SL1050A1	CINTA BIADHESIVA 3 METROS TRANSFER VH	0.820	M	TB1224B0		2	PZ	VI1716A0		4	PZ	VM1025A0	TAPON NILON PA66 V2 GRIS Ø16	4	PZ	VM1059A1		1.500	M	VT1074A0	CRISTAL EXT. 798X424X5 NEGRO XF/XFT199	1	PZ				
Código	Descripción	Cant.	UdM																																										
GN1265A0	GOMA CRISTAL INTERIOR	4	PZ																																										
IP1385A1		0.980	M																																										
IP1508A0		1.360	PZ																																										
SL1050A1	CINTA BIADHESIVA 3 METROS TRANSFER VH	0.820	M																																										
TB1224B0		2	PZ																																										
VI1716A0		4	PZ																																										
VM1025A0	TAPON NILON PA66 V2 GRIS Ø16	4	PZ																																										
VM1059A1		1.500	M																																										
VT1074A0	CRISTAL EXT. 798X424X5 NEGRO XF/XFT199	1	PZ																																										
KDR0001AR	<table border="1"> <thead> <tr> <th>Código</th> <th>Descripción</th> <th>Cant.</th> <th>UdM</th> </tr> </thead> <tbody> <tr> <td>OH2631A0</td> <td></td> <td>1</td> <td>PZ</td> </tr> <tr> <td>ED1011A0</td> <td></td> <td>1</td> <td>PZ</td> </tr> <tr> <td>GN1175A0</td> <td></td> <td>2</td> <td>PZ</td> </tr> <tr> <td>GN1265A0</td> <td>GOMA CRISTAL INTERIOR</td> <td>4</td> <td>PZ</td> </tr> <tr> <td>IP1325B0</td> <td></td> <td>2</td> <td>PZ</td> </tr> <tr> <td>LP1036A1</td> <td></td> <td>1</td> <td>PZ</td> </tr> <tr> <td>MG1015B0</td> <td>EXTREMO MANETA L.MISS/L.MICR O/CHEFTOP</td> <td>2</td> <td>PZ</td> </tr> <tr> <td>ML1002C0</td> <td></td> <td>1</td> <td>PZ</td> </tr> <tr> <td>ML1003A0</td> <td></td> <td>1</td> <td>PZ</td> </tr> <tr> <td>SL1050A1</td> <td>CINTA BIADHESIVA 3 METROS TRANSFER VH</td> <td>0.820</td> <td>M</td> </tr> </tbody> </table>	Código	Descripción	Cant.	UdM	OH2631A0		1	PZ	ED1011A0		1	PZ	GN1175A0		2	PZ	GN1265A0	GOMA CRISTAL INTERIOR	4	PZ	IP1325B0		2	PZ	LP1036A1		1	PZ	MG1015B0	EXTREMO MANETA L.MISS/L.MICR O/CHEFTOP	2	PZ	ML1002C0		1	PZ	ML1003A0		1	PZ	SL1050A1	CINTA BIADHESIVA 3 METROS TRANSFER VH	0.820	M
Código	Descripción	Cant.	UdM																																										
OH2631A0		1	PZ																																										
ED1011A0		1	PZ																																										
GN1175A0		2	PZ																																										
GN1265A0	GOMA CRISTAL INTERIOR	4	PZ																																										
IP1325B0		2	PZ																																										
LP1036A1		1	PZ																																										
MG1015B0	EXTREMO MANETA L.MISS/L.MICR O/CHEFTOP	2	PZ																																										
ML1002C0		1	PZ																																										
ML1003A0		1	PZ																																										
SL1050A1	CINTA BIADHESIVA 3 METROS TRANSFER VH	0.820	M																																										



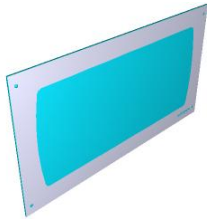

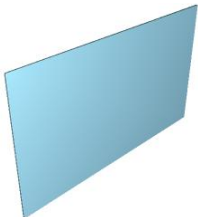
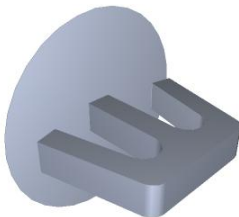
COMPONENTE			REPUESTO																																																																																																						
Código	Descripción	Imagen	Código	Descripción	Lista de componentes																																																																																																				
VT1074A	CRISTAL EXT. 798X424X5 NEGRO XF/XFT199		KDR0001AR	KIT PUERTA COMPLETA ROSSELLA MAGNETIC R	<table border="1"> <thead> <tr> <th>Código</th> <th>Descripción</th> <th>Cant.</th> <th>UdM</th> </tr> </thead> <tbody> <tr><td>SL1140A1</td><td></td><td>1</td><td>ML</td></tr> <tr><td>TB1224B0</td><td></td><td>1</td><td>PZ</td></tr> <tr><td>TB3084A0</td><td></td><td>1</td><td>PZ</td></tr> <tr><td>TF1005A0</td><td></td><td>2</td><td>PZ</td></tr> <tr><td>VI1014A0</td><td></td><td>2</td><td>PZ</td></tr> <tr><td>VI1024A0</td><td></td><td>2</td><td>PZ</td></tr> <tr><td>VI1081A0</td><td></td><td>2</td><td>PZ</td></tr> <tr><td>VI1280A1</td><td></td><td>2</td><td>PZ</td></tr> <tr><td>VI1700A0</td><td></td><td>1</td><td>PZ</td></tr> <tr><td>VI1716A0</td><td></td><td>2</td><td>PZ</td></tr> <tr><td>VI1855A0</td><td></td><td>2</td><td>PZ</td></tr> <tr><td>VM1025A0</td><td>TAPON NILON PA66 V2 GRIS Ø16</td><td>4</td><td>PZ</td></tr> <tr><td>VM1045B0</td><td>TAPON SUPERIOR DERECHO COLUMNNA PUERTA</td><td>1</td><td>PZ</td></tr> <tr><td>VM1046B0</td><td>TAPON INFERIOR IZQUIERDO COLUMNNA PUERTA</td><td>1</td><td>PZ</td></tr> <tr><td>VM1047A0</td><td></td><td>1</td><td>PZ</td></tr> <tr><td>VM1048A0</td><td></td><td>1</td><td>PZ</td></tr> <tr><td>VM1059A1</td><td></td><td>1.500</td><td>M</td></tr> <tr><td>VM1097C0</td><td></td><td>1</td><td>PZ</td></tr> <tr><td>VM1099A0</td><td></td><td>1</td><td>PZ</td></tr> <tr><td>VM1108A0</td><td></td><td>1</td><td>PZ</td></tr> <tr><td>VM1109A0</td><td></td><td>1</td><td>PZ</td></tr> <tr><td>VM2003A0</td><td></td><td>2</td><td>PZ</td></tr> <tr><td>VT1070B0</td><td>CRISTAL INTERNO LINEMISS ROSSELLA</td><td>1</td><td>PZ</td></tr> <tr><td>VT1074A0</td><td>CRISTAL EXT. 798X424X5 NEGRO XF/XFT199</td><td>1</td><td>PZ</td></tr> </tbody> </table>	Código	Descripción	Cant.	UdM	SL1140A1		1	ML	TB1224B0		1	PZ	TB3084A0		1	PZ	TF1005A0		2	PZ	VI1014A0		2	PZ	VI1024A0		2	PZ	VI1081A0		2	PZ	VI1280A1		2	PZ	VI1700A0		1	PZ	VI1716A0		2	PZ	VI1855A0		2	PZ	VM1025A0	TAPON NILON PA66 V2 GRIS Ø16	4	PZ	VM1045B0	TAPON SUPERIOR DERECHO COLUMNNA PUERTA	1	PZ	VM1046B0	TAPON INFERIOR IZQUIERDO COLUMNNA PUERTA	1	PZ	VM1047A0		1	PZ	VM1048A0		1	PZ	VM1059A1		1.500	M	VM1097C0		1	PZ	VM1099A0		1	PZ	VM1108A0		1	PZ	VM1109A0		1	PZ	VM2003A0		2	PZ	VT1070B0	CRISTAL INTERNO LINEMISS ROSSELLA	1	PZ	VT1074A0	CRISTAL EXT. 798X424X5 NEGRO XF/XFT199	1	PZ
			Código	Descripción	Cant.	UdM																																																																																																			
SL1140A1		1	ML																																																																																																						
TB1224B0		1	PZ																																																																																																						
TB3084A0		1	PZ																																																																																																						
TF1005A0		2	PZ																																																																																																						
VI1014A0		2	PZ																																																																																																						
VI1024A0		2	PZ																																																																																																						
VI1081A0		2	PZ																																																																																																						
VI1280A1		2	PZ																																																																																																						
VI1700A0		1	PZ																																																																																																						
VI1716A0		2	PZ																																																																																																						
VI1855A0		2	PZ																																																																																																						
VM1025A0	TAPON NILON PA66 V2 GRIS Ø16	4	PZ																																																																																																						
VM1045B0	TAPON SUPERIOR DERECHO COLUMNNA PUERTA	1	PZ																																																																																																						
VM1046B0	TAPON INFERIOR IZQUIERDO COLUMNNA PUERTA	1	PZ																																																																																																						
VM1047A0		1	PZ																																																																																																						
VM1048A0		1	PZ																																																																																																						
VM1059A1		1.500	M																																																																																																						
VM1097C0		1	PZ																																																																																																						
VM1099A0		1	PZ																																																																																																						
VM1108A0		1	PZ																																																																																																						
VM1109A0		1	PZ																																																																																																						
VM2003A0		2	PZ																																																																																																						
VT1070B0	CRISTAL INTERNO LINEMISS ROSSELLA	1	PZ																																																																																																						
VT1074A0	CRISTAL EXT. 798X424X5 NEGRO XF/XFT199	1	PZ																																																																																																						
KDR0001AL	KIT PUERTA COMPLETA ROSSELLA MAGNETIC L	<table border="1"> <thead> <tr> <th>Código</th> <th>Descripción</th> <th>Cant.</th> <th>UdM</th> </tr> </thead> <tbody> <tr><td>0H2631A0</td><td></td><td>1</td><td>PZ</td></tr> <tr><td>ED1011A0</td><td></td><td>1</td><td>PZ</td></tr> <tr><td>GN1175A0</td><td></td><td>2</td><td>PZ</td></tr> <tr><td>GN1265A0</td><td>GOMA CRISTAL INTERIOR</td><td>4</td><td>PZ</td></tr> <tr><td>IP1325B0</td><td></td><td>2</td><td>PZ</td></tr> <tr><td>LP1036A1</td><td></td><td>1</td><td>PZ</td></tr> <tr><td>MG1015B0</td><td>EXTREMO MANETA L.MISS/L.MICR O/CHEFTOP</td><td>2</td><td>PZ</td></tr> <tr><td>ML1002C0</td><td></td><td>1</td><td>PZ</td></tr> </tbody> </table>	Código	Descripción	Cant.	UdM	0H2631A0		1	PZ	ED1011A0		1	PZ	GN1175A0		2	PZ	GN1265A0	GOMA CRISTAL INTERIOR	4	PZ	IP1325B0		2	PZ	LP1036A1		1	PZ	MG1015B0	EXTREMO MANETA L.MISS/L.MICR O/CHEFTOP	2	PZ	ML1002C0		1	PZ																																																																			
Código	Descripción	Cant.	UdM																																																																																																						
0H2631A0		1	PZ																																																																																																						
ED1011A0		1	PZ																																																																																																						
GN1175A0		2	PZ																																																																																																						
GN1265A0	GOMA CRISTAL INTERIOR	4	PZ																																																																																																						
IP1325B0		2	PZ																																																																																																						
LP1036A1		1	PZ																																																																																																						
MG1015B0	EXTREMO MANETA L.MISS/L.MICR O/CHEFTOP	2	PZ																																																																																																						
ML1002C0		1	PZ																																																																																																						

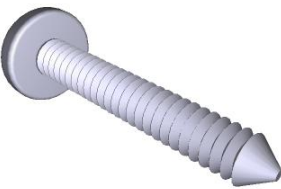
COMPONENTE			REPUESTO																																																																																																																																										
Código	Descripción	Imagen	Código	Descripción	Lista de componentes																																																																																																																																								
VT1074A	CRISTAL EXT. 798X424X5 NEGRO XF/XFT199		KDR0001AL	KIT PUERTA COMPLETA ROSSELLA MAGNETIC L	<table border="1"> <thead> <tr> <th>Código</th> <th>Descripción</th> <th>Cant.</th> <th>UdM</th> </tr> </thead> <tbody> <tr> <td>ML1003A0</td> <td></td> <td>1</td> <td>PZ</td> </tr> <tr> <td>SL1050A1</td> <td>CINTA BIADHESIVA 3 METROS TRANSFER VH</td> <td>0.820</td> <td>M</td> </tr> <tr> <td>SL1140A1</td> <td></td> <td>1</td> <td>ML</td> </tr> <tr> <td>TB1224B0</td> <td></td> <td>1</td> <td>PZ</td> </tr> <tr> <td>TB3084A0</td> <td></td> <td>1</td> <td>PZ</td> </tr> <tr> <td>TF1005A0</td> <td></td> <td>2</td> <td>PZ</td> </tr> <tr> <td>VI1014A0</td> <td></td> <td>2</td> <td>PZ</td> </tr> <tr> <td>VI1024A0</td> <td></td> <td>2</td> <td>PZ</td> </tr> <tr> <td>VI1081A0</td> <td></td> <td>2</td> <td>PZ</td> </tr> <tr> <td>VI1280A1</td> <td></td> <td>2</td> <td>PZ</td> </tr> <tr> <td>VI1700A0</td> <td></td> <td>1</td> <td>PZ</td> </tr> <tr> <td>VI1716A0</td> <td></td> <td>2</td> <td>PZ</td> </tr> <tr> <td>VI1855A0</td> <td></td> <td>2</td> <td>PZ</td> </tr> <tr> <td>VM1025A0</td> <td>TAPON NILON PA66 V2 GRIS Ø16</td> <td>4</td> <td>PZ</td> </tr> <tr> <td>VM1045B0</td> <td>TAPON SUPERIOR DERECHO COLUMNNA PUERTA</td> <td>1</td> <td>PZ</td> </tr> <tr> <td>VM1046B0</td> <td>TAPON INFERIOR IZQUIERDO COLUMNNA PUERTA</td> <td>1</td> <td>PZ</td> </tr> <tr> <td>VM1047A0</td> <td></td> <td>1</td> <td>PZ</td> </tr> <tr> <td>VM1048A0</td> <td></td> <td>1</td> <td>PZ</td> </tr> <tr> <td>VM1059A1</td> <td></td> <td>1.500</td> <td>M</td> </tr> <tr> <td>VM1097C0</td> <td></td> <td>1</td> <td>PZ</td> </tr> <tr> <td>VM1099A0</td> <td></td> <td>1</td> <td>PZ</td> </tr> <tr> <td>VM1108A0</td> <td></td> <td>1</td> <td>PZ</td> </tr> <tr> <td>VM1109A0</td> <td></td> <td>1</td> <td>PZ</td> </tr> <tr> <td>VM2003A0</td> <td></td> <td>2</td> <td>PZ</td> </tr> <tr> <td>VT1070B0</td> <td>CRISTAL INTERNO LINEMISS ROSSELLA</td> <td>1</td> <td>PZ</td> </tr> <tr> <td>VT1074A0</td> <td>CRISTAL EXT. 798X424X5 NEGRO XF/XFT199</td> <td>1</td> <td>PZ</td> </tr> </tbody> </table>		Código	Descripción	Cant.	UdM	ML1003A0		1	PZ	SL1050A1	CINTA BIADHESIVA 3 METROS TRANSFER VH	0.820	M	SL1140A1		1	ML	TB1224B0		1	PZ	TB3084A0		1	PZ	TF1005A0		2	PZ	VI1014A0		2	PZ	VI1024A0		2	PZ	VI1081A0		2	PZ	VI1280A1		2	PZ	VI1700A0		1	PZ	VI1716A0		2	PZ	VI1855A0		2	PZ	VM1025A0	TAPON NILON PA66 V2 GRIS Ø16	4	PZ	VM1045B0	TAPON SUPERIOR DERECHO COLUMNNA PUERTA	1	PZ	VM1046B0	TAPON INFERIOR IZQUIERDO COLUMNNA PUERTA	1	PZ	VM1047A0		1	PZ	VM1048A0		1	PZ	VM1059A1		1.500	M	VM1097C0		1	PZ	VM1099A0		1	PZ	VM1108A0		1	PZ	VM1109A0		1	PZ	VM2003A0		2	PZ	VT1070B0	CRISTAL INTERNO LINEMISS ROSSELLA	1	PZ	VT1074A0	CRISTAL EXT. 798X424X5 NEGRO XF/XFT199	1	PZ	KDR0001A	<table border="1"> <thead> <tr> <th>Código</th> <th>Descripción</th> <th>Cant.</th> <th>UdM</th> </tr> </thead> <tbody> <tr> <td>0H2631A0</td> <td></td> <td>1</td> <td>PZ</td> </tr> <tr> <td>ED1011A0</td> <td></td> <td>1</td> <td>PZ</td> </tr> <tr> <td>GN1175A0</td> <td></td> <td>2</td> <td>PZ</td> </tr> <tr> <td>GN1265A0</td> <td>GOMA CRISTAL INTERIOR</td> <td>4</td> <td>PZ</td> </tr> <tr> <td>IP1325B0</td> <td></td> <td>2</td> <td>PZ</td> </tr> </tbody> </table>		Código	Descripción	Cant.	UdM	0H2631A0		1	PZ	ED1011A0		1	PZ	GN1175A0		2	PZ	GN1265A0	GOMA CRISTAL INTERIOR	4	PZ	IP1325B0		2	PZ
			Código		Descripción	Cant.	UdM																																																																																																																																						
ML1003A0		1	PZ																																																																																																																																										
SL1050A1	CINTA BIADHESIVA 3 METROS TRANSFER VH	0.820	M																																																																																																																																										
SL1140A1		1	ML																																																																																																																																										
TB1224B0		1	PZ																																																																																																																																										
TB3084A0		1	PZ																																																																																																																																										
TF1005A0		2	PZ																																																																																																																																										
VI1014A0		2	PZ																																																																																																																																										
VI1024A0		2	PZ																																																																																																																																										
VI1081A0		2	PZ																																																																																																																																										
VI1280A1		2	PZ																																																																																																																																										
VI1700A0		1	PZ																																																																																																																																										
VI1716A0		2	PZ																																																																																																																																										
VI1855A0		2	PZ																																																																																																																																										
VM1025A0	TAPON NILON PA66 V2 GRIS Ø16	4	PZ																																																																																																																																										
VM1045B0	TAPON SUPERIOR DERECHO COLUMNNA PUERTA	1	PZ																																																																																																																																										
VM1046B0	TAPON INFERIOR IZQUIERDO COLUMNNA PUERTA	1	PZ																																																																																																																																										
VM1047A0		1	PZ																																																																																																																																										
VM1048A0		1	PZ																																																																																																																																										
VM1059A1		1.500	M																																																																																																																																										
VM1097C0		1	PZ																																																																																																																																										
VM1099A0		1	PZ																																																																																																																																										
VM1108A0		1	PZ																																																																																																																																										
VM1109A0		1	PZ																																																																																																																																										
VM2003A0		2	PZ																																																																																																																																										
VT1070B0	CRISTAL INTERNO LINEMISS ROSSELLA	1	PZ																																																																																																																																										
VT1074A0	CRISTAL EXT. 798X424X5 NEGRO XF/XFT199	1	PZ																																																																																																																																										
Código	Descripción	Cant.	UdM																																																																																																																																										
0H2631A0		1	PZ																																																																																																																																										
ED1011A0		1	PZ																																																																																																																																										
GN1175A0		2	PZ																																																																																																																																										
GN1265A0	GOMA CRISTAL INTERIOR	4	PZ																																																																																																																																										
IP1325B0		2	PZ																																																																																																																																										



COMPONENTE			REPUESTO					
Código	Descripción	Imagen	Código	Descripción	Lista de componentes			
VT1074A	CRISTAL EXT. 798X424X5 NEGRO XF/XFT199		KDR0001A		Código	Descripción	Cant.	UdM
					MG1015B0	EXTREMO MANETA L.MISS/L.MICR O/CHEFTOP	2	PZ
					ML1002C0		1	PZ
					ML1003A0		1	PZ
					SL1050A1	CINTA BIADHESIVA 3 METROS TRANSFER VH	0.820	M
					SL1140A1		1	ML
					TB1224B0		2	PZ
					TF1005A0		2	PZ
					VI1014A0		4	PZ
					VI1024A0		4	PZ
					VI1081A0		2	PZ
					VI1280A1		2	PZ
					VI1700A0		1	PZ
					VI1716A0		4	PZ
					VI1855A0		2	PZ
					VM1025A0	TAPON NILON PA66 V2 GRIS Ø16	4	PZ
					VM1045B0	TAPON SUPERIOR DERECHO COLUMNNA PUERTA	1	PZ
					VM1046B0	TAPON INFERIOR IZQUIERDO COLUMNNA PUERTA	1	PZ
					VM1047A0		1	PZ
					VM1048A0		1	PZ
					VM1059A1		1.500	M
					VM1097C0		1	PZ
					VM1099A0		1	PZ
					VM1108A0		1	PZ
					VM1109A0		1	PZ
					VM2003A0		2	PZ
					VT1070B0	CRISTAL INTERNO LINEMISS ROSSELLA	1	PZ
					VT1074A0	CRISTAL EXT. 798X424X5 NEGRO XF/XFT199	1	PZ

COMPONENTE			REPUESTO																														
Código	Descripción	Imagen	Código	Descripción	Lista de componentes																												
VT1070B	CRISTAL INTERNO LINEMISS ROSSELL		KVT1070B	KIT CRISTAL INTERNO ROSSELLA VT1070B	<table border="1"> <thead> <tr> <th>Código</th> <th>Descripción</th> <th>Cant.</th> <th>UdM</th> </tr> </thead> <tbody> <tr> <td>ED1011A0</td> <td></td> <td>1</td> <td>PZ</td> </tr> <tr> <td>ED1235A0</td> <td></td> <td>1</td> <td>PZ</td> </tr> <tr> <td>GN1265A0</td> <td>GOMA CRISTAL INTERIOR</td> <td>4</td> <td>PZ</td> </tr> <tr> <td>IP1508A0</td> <td></td> <td>1.130</td> <td>PZ</td> </tr> <tr> <td>VM1059A1</td> <td></td> <td>1.700</td> <td>M</td> </tr> <tr> <td>VT1070B0</td> <td>CRISTAL INTERNO LINEMISS ROSSELLA</td> <td>1</td> <td>PZ</td> </tr> </tbody> </table>	Código	Descripción	Cant.	UdM	ED1011A0		1	PZ	ED1235A0		1	PZ	GN1265A0	GOMA CRISTAL INTERIOR	4	PZ	IP1508A0		1.130	PZ	VM1059A1		1.700	M	VT1070B0	CRISTAL INTERNO LINEMISS ROSSELLA	1	PZ
Código	Descripción	Cant.	UdM																														
ED1011A0		1	PZ																														
ED1235A0		1	PZ																														
GN1265A0	GOMA CRISTAL INTERIOR	4	PZ																														
IP1508A0		1.130	PZ																														
VM1059A1		1.700	M																														
VT1070B0	CRISTAL INTERNO LINEMISS ROSSELLA	1	PZ																														
VM1025A	TAPON NILON PA66 V2 GRIS Ø16		KVM1025A	KIT 20 TAPONES NYLON GRIS	<table border="1"> <thead> <tr> <th>Código</th> <th>Descripción</th> <th>Cant.</th> <th>UdM</th> </tr> </thead> <tbody> <tr> <td>VM1025A0</td> <td>TAPON NILON PA66 V2 GRIS Ø16</td> <td>20</td> <td>PZ</td> </tr> </tbody> </table>	Código	Descripción	Cant.	UdM	VM1025A0	TAPON NILON PA66 V2 GRIS Ø16	20	PZ																				
Código	Descripción	Cant.	UdM																														
VM1025A0	TAPON NILON PA66 V2 GRIS Ø16	20	PZ																														
MG1015B	EXTREMO MANETA L.MISS/L.MICRO/CH EFTOP		KMG1015B	KIT SOPORTE MANETA 2 UDS.	<table border="1"> <thead> <tr> <th>Código</th> <th>Descripción</th> <th>Cant.</th> <th>UdM</th> </tr> </thead> <tbody> <tr> <td>MG1015B0</td> <td>EXTREMO MANETA L.MISS/L.MICR O/CHEFTOP</td> <td>2</td> <td>PZ</td> </tr> <tr> <td>VI1855A0</td> <td></td> <td>2</td> <td>PZ</td> </tr> <tr> <td>VI1870A0</td> <td></td> <td>2</td> <td>PZ</td> </tr> <tr> <td>VM1025A0</td> <td>TAPON NILON PA66 V2 GRIS Ø16</td> <td>2</td> <td>PZ</td> </tr> </tbody> </table>	Código	Descripción	Cant.	UdM	MG1015B0	EXTREMO MANETA L.MISS/L.MICR O/CHEFTOP	2	PZ	VI1855A0		2	PZ	VI1870A0		2	PZ	VM1025A0	TAPON NILON PA66 V2 GRIS Ø16	2	PZ								
Código	Descripción	Cant.	UdM																														
MG1015B0	EXTREMO MANETA L.MISS/L.MICR O/CHEFTOP	2	PZ																														
VI1855A0		2	PZ																														
VI1870A0		2	PZ																														
VM1025A0	TAPON NILON PA66 V2 GRIS Ø16	2	PZ																														
VI1855A			KVI1855A	KIT TORNILLO	<table border="1"> <thead> <tr> <th>Código</th> <th>Descripción</th> <th>Cant.</th> <th>UdM</th> </tr> </thead> <tbody> <tr> <td>VI1855A0</td> <td></td> <td>20</td> <td>PZ</td> </tr> </tbody> </table>	Código	Descripción	Cant.	UdM	VI1855A0		20	PZ																				
Código	Descripción	Cant.	UdM																														
VI1855A0		20	PZ																														
0H2631A			K0H2631A	KIT MANETA XF190 0H2631A	<table border="1"> <thead> <tr> <th>Código</th> <th>Descripción</th> <th>Cant.</th> <th>UdM</th> </tr> </thead> <tbody> <tr> <td>0H2631A0</td> <td></td> <td>1</td> <td>PZ</td> </tr> <tr> <td>MG1015B0</td> <td>EXTREMO MANETA L.MISS/L.MICR O/CHEFTOP</td> <td>2</td> <td>PZ</td> </tr> <tr> <td>VI1855A0</td> <td></td> <td>2</td> <td>PZ</td> </tr> <tr> <td>VM1025A0</td> <td>TAPON NILON PA66 V2 GRIS Ø16</td> <td>2</td> <td>PZ</td> </tr> </tbody> </table>	Código	Descripción	Cant.	UdM	0H2631A0		1	PZ	MG1015B0	EXTREMO MANETA L.MISS/L.MICR O/CHEFTOP	2	PZ	VI1855A0		2	PZ	VM1025A0	TAPON NILON PA66 V2 GRIS Ø16	2	PZ								
Código	Descripción	Cant.	UdM																														
0H2631A0		1	PZ																														
MG1015B0	EXTREMO MANETA L.MISS/L.MICR O/CHEFTOP	2	PZ																														
VI1855A0		2	PZ																														
VM1025A0	TAPON NILON PA66 V2 GRIS Ø16	2	PZ																														

COMPONENTE			REPUESTO										
Código	Descripción	Imagen	Código	Descripción	Lista de componentes								
VM1045B	TAPON SUPERIOR DERECHO COLUMNA PUERTA		KVM1045B		<table border="1"> <thead> <tr> <th>Código</th> <th>Descripción</th> <th>Cant.</th> <th>UdM</th> </tr> </thead> <tbody> <tr> <td>VM1045B0</td> <td>TAPON SUPERIOR DERECHO COLUMNA PUERTA</td> <td>1</td> <td>PZ</td> </tr> </tbody> </table>	Código	Descripción	Cant.	UdM	VM1045B0	TAPON SUPERIOR DERECHO COLUMNA PUERTA	1	PZ
Código	Descripción	Cant.	UdM										
VM1045B0	TAPON SUPERIOR DERECHO COLUMNA PUERTA	1	PZ										
VM1046B	TAPON INFERIOR IZQUIERDO COLUMNA PUERTA		KVM1046B		<table border="1"> <thead> <tr> <th>Código</th> <th>Descripción</th> <th>Cant.</th> <th>UdM</th> </tr> </thead> <tbody> <tr> <td>VM1046B0</td> <td>TAPON INFERIOR IZQUIERDO COLUMNA PUERTA</td> <td>1</td> <td>PZ</td> </tr> </tbody> </table>	Código	Descripción	Cant.	UdM	VM1046B0	TAPON INFERIOR IZQUIERDO COLUMNA PUERTA	1	PZ
Código	Descripción	Cant.	UdM										
VM1046B0	TAPON INFERIOR IZQUIERDO COLUMNA PUERTA	1	PZ										
VM1047A			VM1047A0										
VM1048A			VM1048A0										
GN1265A	GOMA CRISTAL INTERIOR		KGN1265A	KIT 4GOMAS CRIST. INT.XVC055-105/XF1 8-19	<table border="1"> <thead> <tr> <th>Código</th> <th>Descripción</th> <th>Cant.</th> <th>UdM</th> </tr> </thead> <tbody> <tr> <td>GN1265A0</td> <td>GOMA CRISTAL INTERIOR</td> <td>4</td> <td>PZ</td> </tr> </tbody> </table>	Código	Descripción	Cant.	UdM	GN1265A0	GOMA CRISTAL INTERIOR	4	PZ
Código	Descripción	Cant.	UdM										
GN1265A0	GOMA CRISTAL INTERIOR	4	PZ										

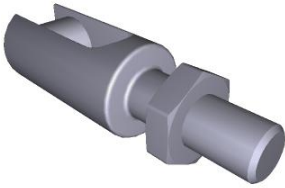
COMPONENTE			REPUESTO																		
Código	Descripción	Imagen	Código	Descripción	Lista de componentes																
TF1005A			KTF1005A		<table border="1"> <thead> <tr> <th>Código</th> <th>Descripción</th> <th>Cant.</th> <th>UdM</th> </tr> </thead> <tbody> <tr> <td>GN1175A0</td> <td></td> <td>1</td> <td>PZ</td> </tr> <tr> <td>TF1005A0</td> <td></td> <td>1</td> <td>PZ</td> </tr> <tr> <td>VI1875A0</td> <td></td> <td>1</td> <td>PZ</td> </tr> </tbody> </table>	Código	Descripción	Cant.	UdM	GN1175A0		1	PZ	TF1005A0		1	PZ	VI1875A0		1	PZ
Código	Descripción	Cant.	UdM																		
GN1175A0		1	PZ																		
TF1005A0		1	PZ																		
VI1875A0		1	PZ																		
VM1025A	TAPON NILON PA66 V2 GRIS Ø16		KVM1025A	KIT 20 TAPONES NYLON GRIS	<table border="1"> <thead> <tr> <th>Código</th> <th>Descripción</th> <th>Cant.</th> <th>UdM</th> </tr> </thead> <tbody> <tr> <td>VM1025A0</td> <td>TAPON NILON PA66 V2 GRIS Ø16</td> <td>20</td> <td>PZ</td> </tr> </tbody> </table>	Código	Descripción	Cant.	UdM	VM1025A0	TAPON NILON PA66 V2 GRIS Ø16	20	PZ								
Código	Descripción	Cant.	UdM																		
VM1025A0	TAPON NILON PA66 V2 GRIS Ø16	20	PZ																		
CR1040A	PIVOT PARA CERRADURA ELECTROMAGNETI CA		KCR1040A		<table border="1"> <thead> <tr> <th>Código</th> <th>Descripción</th> <th>Cant.</th> <th>UdM</th> </tr> </thead> <tbody> <tr> <td>CR1040A0</td> <td>PIVOT PARA CERRADURA ELECTROMAG NETICA</td> <td>1</td> <td>PZ</td> </tr> </tbody> </table>	Código	Descripción	Cant.	UdM	CR1040A0	PIVOT PARA CERRADURA ELECTROMAG NETICA	1	PZ								
Código	Descripción	Cant.	UdM																		
CR1040A0	PIVOT PARA CERRADURA ELECTROMAG NETICA	1	PZ																		
VI1081A			KVI1081A		<table border="1"> <thead> <tr> <th>Código</th> <th>Descripción</th> <th>Cant.</th> <th>UdM</th> </tr> </thead> <tbody> <tr> <td>VI1081A0</td> <td></td> <td>10</td> <td>PZ</td> </tr> </tbody> </table>	Código	Descripción	Cant.	UdM	VI1081A0		10	PZ								
Código	Descripción	Cant.	UdM																		
VI1081A0		10	PZ																		
LP1036A			KLP1036A	KIT BARRA LED L200 LMISS	<table border="1"> <thead> <tr> <th>Código</th> <th>Descripción</th> <th>Cant.</th> <th>UdM</th> </tr> </thead> <tbody> <tr> <td>IP1385A1</td> <td></td> <td>0.700</td> <td>M</td> </tr> <tr> <td>LP1030A0</td> <td></td> <td>1</td> <td>PZ</td> </tr> <tr> <td>VM1058A1</td> <td></td> <td>0.700</td> <td>M</td> </tr> </tbody> </table>	Código	Descripción	Cant.	UdM	IP1385A1		0.700	M	LP1030A0		1	PZ	VM1058A1		0.700	M
Código	Descripción	Cant.	UdM																		
IP1385A1		0.700	M																		
LP1030A0		1	PZ																		
VM1058A1		0.700	M																		

COMPONENTE			REPUESTO		
<i>Código</i>	<i>Descripción</i>	<i>Imagen</i>	<i>Código</i>	<i>Descripción</i>	<i>Lista de componentes</i>
VM2393A			VM2393A0		
VM2394A			VM2394A0		

ASM1441C/0.D00 - Cámara de cocción

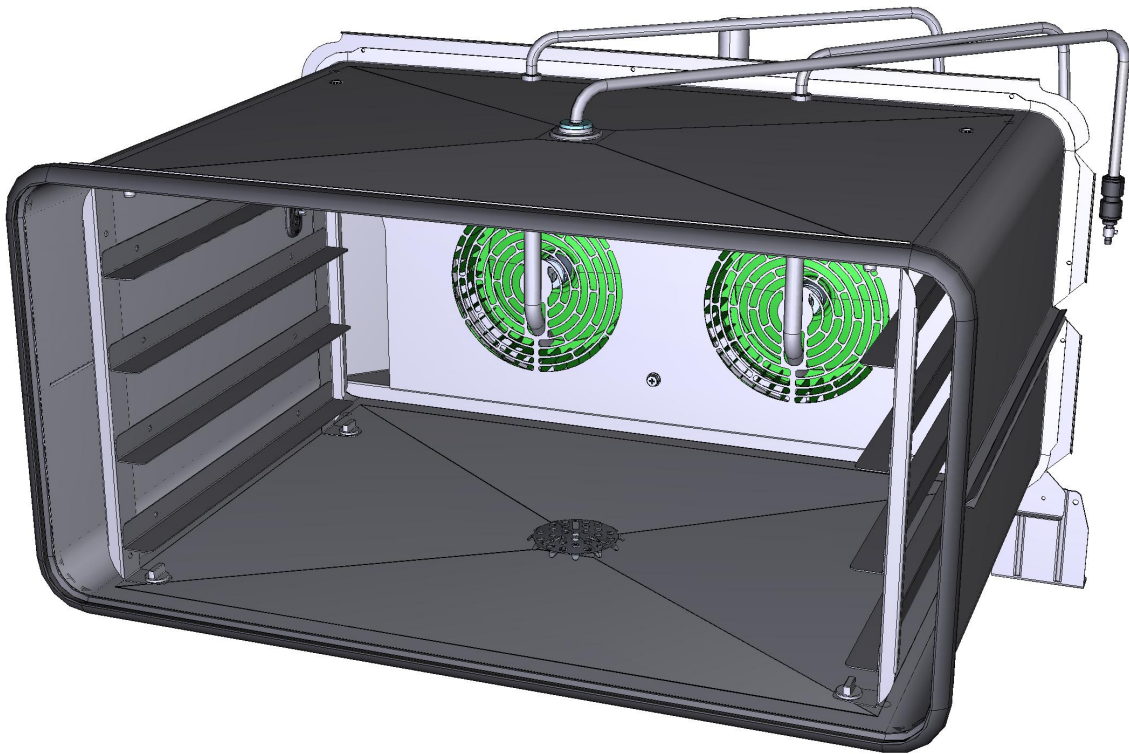

ANVERSO





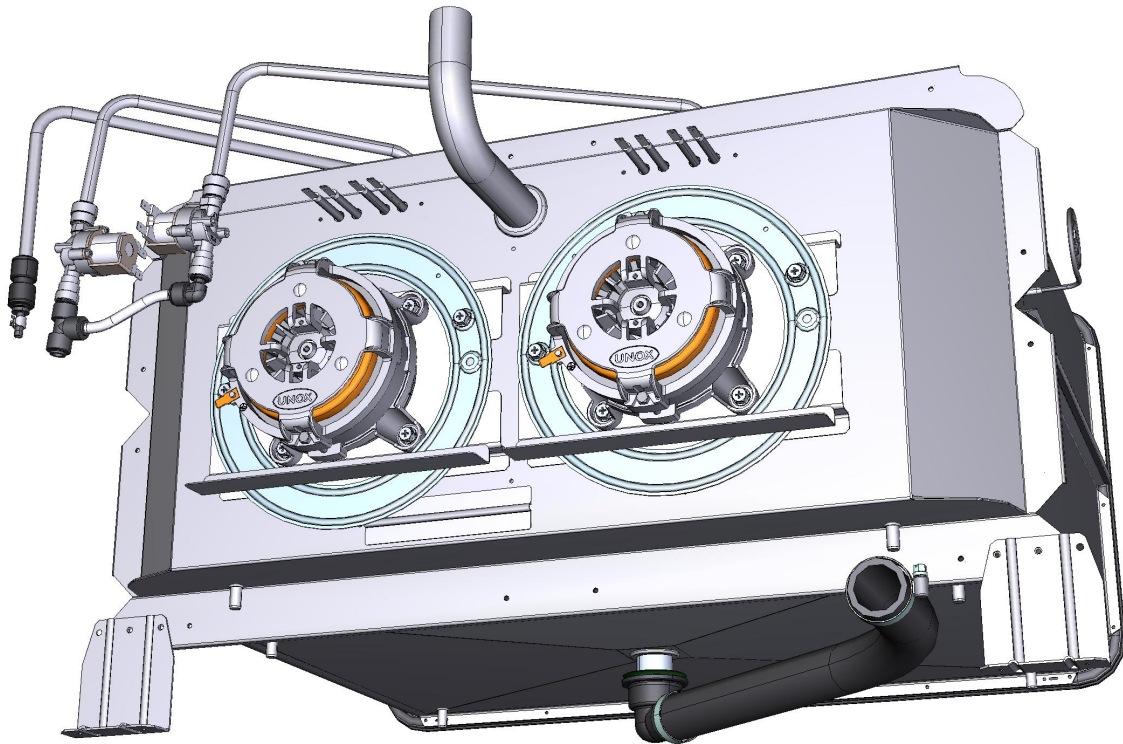

ASM1441C/0.D00 - Cámara de cocción

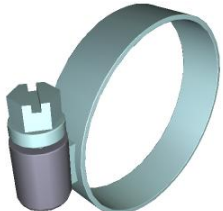
REVERSO







COMPONENTE			REPUESTO																																																										
Código	Descripción	Imagen	Código	Descripción	Lista de componentes																																																								
0H1455A	ESTRIBO SOPORTE CAMARA		0H1455A2	ESTRIBO SOPORTE CAMARA																																																									
0G1536A	CARTER ACERO INOX XFT200 2 TUBOS HUMEDAD		0G1536A1	CARTER ACERO INOX XFT200 2 TUBOS HUMEDAD																																																									
RC1378A			KVE1135A	KIT VENTURI HORNOS SERIE 5/E	<table border="1"> <thead> <tr> <th>Código</th> <th>Descripción</th> <th>Cant.</th> <th>UdM</th> </tr> </thead> <tbody> <tr> <td>GN1310A0</td> <td>GOMA SILICONA VENTURI</td> <td>1</td> <td>PZ</td> </tr> <tr> <td>GN1556A0</td> <td>MM GOMA VENTURI</td> <td>1</td> <td>PZ</td> </tr> <tr> <td>RC1378A0</td> <td></td> <td>2</td> <td>PZ</td> </tr> <tr> <td>TB1520A0</td> <td>TUBO NEGRO D.INT=30 SP=4 GOMA EPDM</td> <td>0.050</td> <td>M</td> </tr> <tr> <td>VE1135A0</td> <td>ENCENDIDO VENTURI 220V 50/60 HZ SERIE 2</td> <td>1</td> <td>PZ</td> </tr> <tr> <td>VI1032A0</td> <td></td> <td>1</td> <td>PZ</td> </tr> <tr> <td>VI1511A0</td> <td></td> <td>2</td> <td>PZ</td> </tr> <tr> <td>VI1850A0</td> <td>TORNILLOS DE FIJACION NIQUELADOS M4X6</td> <td>2</td> <td>PZ</td> </tr> <tr> <td>VI1865A0</td> <td></td> <td>3</td> <td>PZ</td> </tr> <tr> <td>VM1565B0</td> <td>SOPORTE BOBINA INFERIOR VENTURI CT B</td> <td>1</td> <td>PZ</td> </tr> <tr> <td>VM1566A0</td> <td>SOPORTE BOBINA SUPERIOR CT BT</td> <td>1</td> <td>PZ</td> </tr> <tr> <td>VM1567A0</td> <td>ANILLO INFERIOR VENTURI</td> <td>1</td> <td>PZ</td> </tr> <tr> <td>VM1568A0</td> <td>SEPARADOR PLATILLO VENTURI</td> <td>1</td> <td>PZ</td> </tr> </tbody> </table>	Código	Descripción	Cant.	UdM	GN1310A0	GOMA SILICONA VENTURI	1	PZ	GN1556A0	MM GOMA VENTURI	1	PZ	RC1378A0		2	PZ	TB1520A0	TUBO NEGRO D.INT=30 SP=4 GOMA EPDM	0.050	M	VE1135A0	ENCENDIDO VENTURI 220V 50/60 HZ SERIE 2	1	PZ	VI1032A0		1	PZ	VI1511A0		2	PZ	VI1850A0	TORNILLOS DE FIJACION NIQUELADOS M4X6	2	PZ	VI1865A0		3	PZ	VM1565B0	SOPORTE BOBINA INFERIOR VENTURI CT B	1	PZ	VM1566A0	SOPORTE BOBINA SUPERIOR CT BT	1	PZ	VM1567A0	ANILLO INFERIOR VENTURI	1	PZ	VM1568A0	SEPARADOR PLATILLO VENTURI	1	PZ
Código	Descripción	Cant.	UdM																																																										
GN1310A0	GOMA SILICONA VENTURI	1	PZ																																																										
GN1556A0	MM GOMA VENTURI	1	PZ																																																										
RC1378A0		2	PZ																																																										
TB1520A0	TUBO NEGRO D.INT=30 SP=4 GOMA EPDM	0.050	M																																																										
VE1135A0	ENCENDIDO VENTURI 220V 50/60 HZ SERIE 2	1	PZ																																																										
VI1032A0		1	PZ																																																										
VI1511A0		2	PZ																																																										
VI1850A0	TORNILLOS DE FIJACION NIQUELADOS M4X6	2	PZ																																																										
VI1865A0		3	PZ																																																										
VM1565B0	SOPORTE BOBINA INFERIOR VENTURI CT B	1	PZ																																																										
VM1566A0	SOPORTE BOBINA SUPERIOR CT BT	1	PZ																																																										
VM1567A0	ANILLO INFERIOR VENTURI	1	PZ																																																										
VM1568A0	SEPARADOR PLATILLO VENTURI	1	PZ																																																										



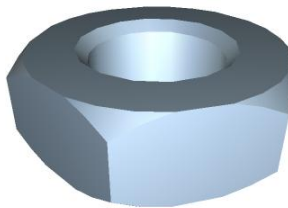
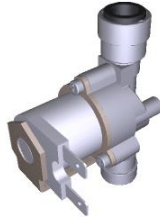

COMPONENTE			REPUESTO																																																										
Código	Descripción	Imagen	Código	Descripción	Lista de componentes																																																								
0H2551A	TAPON TUBO ESCAPE LIQUIDOS INOX XBC/XVC		0H2551A0	TAPON TUBO ESCAPE LIQUIDOS INOX XBC/XVC																																																									
RC1378A			KVE1135A	KIT VENTURI HORNOS SERIE 5/E	<table border="1"> <thead> <tr> <th>Código</th> <th>Descripción</th> <th>Cant.</th> <th>UdM</th> </tr> </thead> <tbody> <tr> <td>GN1310A0</td> <td>GOMA SILICONA VENTURI</td> <td>1</td> <td>PZ</td> </tr> <tr> <td>GN1556A0</td> <td>MM GOMA VENTURI</td> <td>1</td> <td>PZ</td> </tr> <tr> <td>RC1378A0</td> <td></td> <td>2</td> <td>PZ</td> </tr> <tr> <td>TB1520A0</td> <td>TUBO NEGRO D.INT=30 SP=4 GOMA EPDM</td> <td>0.050</td> <td>M</td> </tr> <tr> <td>VE1135A0</td> <td>ENCENDIDO VENTURI 220V 50/60 HZ SERIE 2</td> <td>1</td> <td>PZ</td> </tr> <tr> <td>VI1032A0</td> <td></td> <td>1</td> <td>PZ</td> </tr> <tr> <td>VI1511A0</td> <td></td> <td>2</td> <td>PZ</td> </tr> <tr> <td>VI1850A0</td> <td>TORNILLOS DE FIJACION NIQUELADOS M4X6</td> <td>2</td> <td>PZ</td> </tr> <tr> <td>VI1865A0</td> <td></td> <td>3</td> <td>PZ</td> </tr> <tr> <td>VM1565B0</td> <td>SOPORTE BOBINA INFERIOR VENTURI CT B</td> <td>1</td> <td>PZ</td> </tr> <tr> <td>VM1566A0</td> <td>SOPORTE BOBINA SUPERIOR CT BT</td> <td>1</td> <td>PZ</td> </tr> <tr> <td>VM1567A0</td> <td>ANILLO INFERIOR VENTURI</td> <td>1</td> <td>PZ</td> </tr> <tr> <td>VM1568A0</td> <td>SEPARADOR PLATILLO VENTURI</td> <td>1</td> <td>PZ</td> </tr> </tbody> </table>	Código	Descripción	Cant.	UdM	GN1310A0	GOMA SILICONA VENTURI	1	PZ	GN1556A0	MM GOMA VENTURI	1	PZ	RC1378A0		2	PZ	TB1520A0	TUBO NEGRO D.INT=30 SP=4 GOMA EPDM	0.050	M	VE1135A0	ENCENDIDO VENTURI 220V 50/60 HZ SERIE 2	1	PZ	VI1032A0		1	PZ	VI1511A0		2	PZ	VI1850A0	TORNILLOS DE FIJACION NIQUELADOS M4X6	2	PZ	VI1865A0		3	PZ	VM1565B0	SOPORTE BOBINA INFERIOR VENTURI CT B	1	PZ	VM1566A0	SOPORTE BOBINA SUPERIOR CT BT	1	PZ	VM1567A0	ANILLO INFERIOR VENTURI	1	PZ	VM1568A0	SEPARADOR PLATILLO VENTURI	1	PZ
Código	Descripción	Cant.	UdM																																																										
GN1310A0	GOMA SILICONA VENTURI	1	PZ																																																										
GN1556A0	MM GOMA VENTURI	1	PZ																																																										
RC1378A0		2	PZ																																																										
TB1520A0	TUBO NEGRO D.INT=30 SP=4 GOMA EPDM	0.050	M																																																										
VE1135A0	ENCENDIDO VENTURI 220V 50/60 HZ SERIE 2	1	PZ																																																										
VI1032A0		1	PZ																																																										
VI1511A0		2	PZ																																																										
VI1850A0	TORNILLOS DE FIJACION NIQUELADOS M4X6	2	PZ																																																										
VI1865A0		3	PZ																																																										
VM1565B0	SOPORTE BOBINA INFERIOR VENTURI CT B	1	PZ																																																										
VM1566A0	SOPORTE BOBINA SUPERIOR CT BT	1	PZ																																																										
VM1567A0	ANILLO INFERIOR VENTURI	1	PZ																																																										
VM1568A0	SEPARADOR PLATILLO VENTURI	1	PZ																																																										
VL1026A			KVL1026A	KIT CURVA PARA TUBO DE DESAGUE	<table border="1"> <thead> <tr> <th>Código</th> <th>Descripción</th> <th>Cant.</th> <th>UdM</th> </tr> </thead> <tbody> <tr> <td>GN1400A0</td> <td></td> <td>1</td> <td>PZ</td> </tr> <tr> <td>VL1026A0</td> <td></td> <td>1</td> <td>PZ</td> </tr> <tr> <td>VM2039A0</td> <td></td> <td>1</td> <td>PZ</td> </tr> </tbody> </table>	Código	Descripción	Cant.	UdM	GN1400A0		1	PZ	VL1026A0		1	PZ	VM2039A0		1	PZ																																								
Código	Descripción	Cant.	UdM																																																										
GN1400A0		1	PZ																																																										
VL1026A0		1	PZ																																																										
VM2039A0		1	PZ																																																										

COMPONENTE			REPUESTO																						
Código	Descripción	Imagen	Código	Descripción	Lista de componentes																				
0H3586A	PANEL PROTECCION MOTOR CINCADO XBC-XVC		0H3586A0	PANEL PROTECCION MOTOR CINCADO XBC-XVC																					
VN1025A	TURBINA D=196 H=61 38 PALETAS ACERO INOX		KVN1025A	KIT TURBINA D196 H61 VN1025A	<table border="1"> <thead> <tr> <th>Código</th> <th>Descripción</th> <th>Cant.</th> <th>UdM</th> </tr> </thead> <tbody> <tr> <td>VI1045A0</td> <td>ES-ROSETTA 16X8,4 SP.1,6 INOX UNI6592</td> <td>1</td> <td>PZ</td> </tr> <tr> <td>VI1255A0</td> <td></td> <td>2</td> <td>PZ</td> </tr> <tr> <td>VN1025A2</td> <td>TURBINA D=196 H=61 38 PALETAS ACERO INOX</td> <td>1</td> <td>PZ</td> </tr> </tbody> </table>	Código	Descripción	Cant.	UdM	VI1045A0	ES-ROSETTA 16X8,4 SP.1,6 INOX UNI6592	1	PZ	VI1255A0		2	PZ	VN1025A2	TURBINA D=196 H=61 38 PALETAS ACERO INOX	1	PZ				
Código	Descripción	Cant.	UdM																						
VI1045A0	ES-ROSETTA 16X8,4 SP.1,6 INOX UNI6592	1	PZ																						
VI1255A0		2	PZ																						
VN1025A2	TURBINA D=196 H=61 38 PALETAS ACERO INOX	1	PZ																						
0H1209A	ALETA TERMICA AIRE MOTOR		0H1209A0	ALETA TERMICA AIRE MOTOR																					
GN1140A	GOMA SUJETA MOTOR		KGN1140A	KIT 5 UDS GOMA PORTAMOTOR	<table border="1"> <thead> <tr> <th>Código</th> <th>Descripción</th> <th>Cant.</th> <th>UdM</th> </tr> </thead> <tbody> <tr> <td>GN1140A2</td> <td>GOMA SUJETA MOTOR</td> <td>5</td> <td>PZ</td> </tr> </tbody> </table>	Código	Descripción	Cant.	UdM	GN1140A2	GOMA SUJETA MOTOR	5	PZ												
Código	Descripción	Cant.	UdM																						
GN1140A2	GOMA SUJETA MOTOR	5	PZ																						
0H4305A			K0H4305A	KIT DISCO SELLADO PARA EJE MOTOR	<table border="1"> <thead> <tr> <th>Código</th> <th>Descripción</th> <th>Cant.</th> <th>UdM</th> </tr> </thead> <tbody> <tr> <td>0H4305A1</td> <td></td> <td>1</td> <td>PZ</td> </tr> <tr> <td>GN1140A2</td> <td>GOMA SUJETA MOTOR</td> <td>1</td> <td>PZ</td> </tr> <tr> <td>SL1045A0</td> <td>SILICONA ANTRACITA S53 SP-5007 80ML</td> <td>1</td> <td>PZ</td> </tr> <tr> <td>VI1220A1</td> <td>VITE AUTOFIL. 4.2X12 TCB MARUTEX</td> <td>3</td> <td>PZ</td> </tr> </tbody> </table>	Código	Descripción	Cant.	UdM	0H4305A1		1	PZ	GN1140A2	GOMA SUJETA MOTOR	1	PZ	SL1045A0	SILICONA ANTRACITA S53 SP-5007 80ML	1	PZ	VI1220A1	VITE AUTOFIL. 4.2X12 TCB MARUTEX	3	PZ
Código	Descripción	Cant.	UdM																						
0H4305A1		1	PZ																						
GN1140A2	GOMA SUJETA MOTOR	1	PZ																						
SL1045A0	SILICONA ANTRACITA S53 SP-5007 80ML	1	PZ																						
VI1220A1	VITE AUTOFIL. 4.2X12 TCB MARUTEX	3	PZ																						



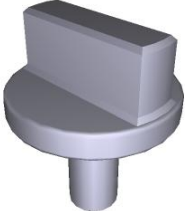

COMPONENTE			REPUESTO																														
Código	Descripción	Imagen	Código	Descripción	Lista de componentes																												
VN1130A	MOTOR HORNO 330W 230V 50/60HZ		KVN1130A	KIT MOTOR	<table border="1"> <thead> <tr> <th>Código</th> <th>Descripción</th> <th>Cant.</th> <th>UdM</th> </tr> </thead> <tbody> <tr> <td>GN1140A2</td> <td>GOMA SUJETA MOTOR</td> <td>1</td> <td>PZ</td> </tr> <tr> <td>VI1045A0</td> <td>ES-ROSETTA 16X8,4 SP.1,6 INOX UNI6592</td> <td>1</td> <td>PZ</td> </tr> <tr> <td>VI1255A0</td> <td></td> <td>2</td> <td>PZ</td> </tr> <tr> <td>VM1794A0</td> <td>ABRAZADERA NEGRA 250X4,8 PA66</td> <td>4</td> <td>PZ</td> </tr> <tr> <td>VM2103A0</td> <td>PLAQUETA FIJA ABRAZADERA</td> <td>4</td> <td>PZ</td> </tr> <tr> <td>VN1130A1</td> <td>MOTOR HORNO 330W 230V 50/60HZ</td> <td>1</td> <td>PZ</td> </tr> </tbody> </table>	Código	Descripción	Cant.	UdM	GN1140A2	GOMA SUJETA MOTOR	1	PZ	VI1045A0	ES-ROSETTA 16X8,4 SP.1,6 INOX UNI6592	1	PZ	VI1255A0		2	PZ	VM1794A0	ABRAZADERA NEGRA 250X4,8 PA66	4	PZ	VM2103A0	PLAQUETA FIJA ABRAZADERA	4	PZ	VN1130A1	MOTOR HORNO 330W 230V 50/60HZ	1	PZ
Código	Descripción	Cant.	UdM																														
GN1140A2	GOMA SUJETA MOTOR	1	PZ																														
VI1045A0	ES-ROSETTA 16X8,4 SP.1,6 INOX UNI6592	1	PZ																														
VI1255A0		2	PZ																														
VM1794A0	ABRAZADERA NEGRA 250X4,8 PA66	4	PZ																														
VM2103A0	PLAQUETA FIJA ABRAZADERA	4	PZ																														
VN1130A1	MOTOR HORNO 330W 230V 50/60HZ	1	PZ																														
RS1271A			KRS1271A	KIT RESISTENCIA LMISS TOP 2900W+110W 230	<table border="1"> <thead> <tr> <th>Código</th> <th>Descripción</th> <th>Cant.</th> <th>UdM</th> </tr> </thead> <tbody> <tr> <td>GN1327A0</td> <td>GOMA RESISTENCIA 100X22</td> <td>1</td> <td>PZ</td> </tr> <tr> <td>RS1271A0</td> <td>RESISTENCIA CIRCULAR 2900W 230V+110W</td> <td>1</td> <td>PZ</td> </tr> <tr> <td>SL1045A0</td> <td>SILICONA ANTRACITA S53 SP-5007 80ML</td> <td>1</td> <td>PZ</td> </tr> <tr> <td>VI1220A1</td> <td>VITE AUTOFIL. 4.2X12 TCB MARUTEX</td> <td>6</td> <td>PZ</td> </tr> <tr> <td>VM1794A0</td> <td>ABRAZADERA NEGRA 250X4,8 PA66</td> <td>2</td> <td>PZ</td> </tr> <tr> <td>VM2103A0</td> <td>PLAQUETA FIJA ABRAZADERA</td> <td>2</td> <td>PZ</td> </tr> </tbody> </table>	Código	Descripción	Cant.	UdM	GN1327A0	GOMA RESISTENCIA 100X22	1	PZ	RS1271A0	RESISTENCIA CIRCULAR 2900W 230V+110W	1	PZ	SL1045A0	SILICONA ANTRACITA S53 SP-5007 80ML	1	PZ	VI1220A1	VITE AUTOFIL. 4.2X12 TCB MARUTEX	6	PZ	VM1794A0	ABRAZADERA NEGRA 250X4,8 PA66	2	PZ	VM2103A0	PLAQUETA FIJA ABRAZADERA	2	PZ
Código	Descripción	Cant.	UdM																														
GN1327A0	GOMA RESISTENCIA 100X22	1	PZ																														
RS1271A0	RESISTENCIA CIRCULAR 2900W 230V+110W	1	PZ																														
SL1045A0	SILICONA ANTRACITA S53 SP-5007 80ML	1	PZ																														
VI1220A1	VITE AUTOFIL. 4.2X12 TCB MARUTEX	6	PZ																														
VM1794A0	ABRAZADERA NEGRA 250X4,8 PA66	2	PZ																														
VM2103A0	PLAQUETA FIJA ABRAZADERA	2	PZ																														
TB1098A			TB1098A0																														

COMPONENTE			REPUESTO																														
Código	Descripción	Imagen	Código	Descripción	Lista de componentes																												
RC1170A	TUERCA M=14 H=8 CH=22 INOX		KRC1170A	KIT 10 TUERCAS M14 H8 CH22	<table border="1"> <thead> <tr> <th>Código</th> <th>Descripción</th> <th>Cant.</th> <th>UdM</th> </tr> </thead> <tbody> <tr> <td>RC1170A1</td> <td>TUERCA M=14 H=8 CH=22 INOX</td> <td>10</td> <td>PZ</td> </tr> </tbody> </table>	Código	Descripción	Cant.	UdM	RC1170A1	TUERCA M=14 H=8 CH=22 INOX	10	PZ																				
Código	Descripción	Cant.	UdM																														
RC1170A1	TUERCA M=14 H=8 CH=22 INOX	10	PZ																														
0H1990A	TUBO EXTERNO HUMEDAD + RC1165A0		0H1990A1	TUBO EXTERNO HUMEDAD + RC1165A0																													
EL1251A			KEL1251A	KIT ELECTROVALVULA 1 VIA J.G. D8-D	<table border="1"> <thead> <tr> <th>Código</th> <th>Descripción</th> <th>Cant.</th> <th>UdM</th> </tr> </thead> <tbody> <tr> <td>EL1251A0</td> <td></td> <td>1</td> <td>PZ</td> </tr> </tbody> </table>	Código	Descripción	Cant.	UdM	EL1251A0		1	PZ																				
Código	Descripción	Cant.	UdM																														
EL1251A0		1	PZ																														
VL1050A			KVL1050A	KIT BRAZO SISTEMA LAVADO LINE MISS TOP	<table border="1"> <thead> <tr> <th>Código</th> <th>Descripción</th> <th>Cant.</th> <th>UdM</th> </tr> </thead> <tbody> <tr> <td>GN1417A0</td> <td></td> <td>1</td> <td>PZ</td> </tr> <tr> <td>UG1014A0</td> <td></td> <td>2</td> <td>PZ</td> </tr> <tr> <td>VL1051A0</td> <td></td> <td>1</td> <td>PZ</td> </tr> <tr> <td>VL1052A0</td> <td></td> <td>1</td> <td>PZ</td> </tr> <tr> <td>VM1039A0</td> <td></td> <td>1</td> <td>PZ</td> </tr> <tr> <td>VM1041A0</td> <td></td> <td>1</td> <td>PZ</td> </tr> </tbody> </table>	Código	Descripción	Cant.	UdM	GN1417A0		1	PZ	UG1014A0		2	PZ	VL1051A0		1	PZ	VL1052A0		1	PZ	VM1039A0		1	PZ	VM1041A0		1	PZ
Código	Descripción	Cant.	UdM																														
GN1417A0		1	PZ																														
UG1014A0		2	PZ																														
VL1051A0		1	PZ																														
VL1052A0		1	PZ																														
VM1039A0		1	PZ																														
VM1041A0		1	PZ																														
EL1055A	RACOR J.G. DE D=10 A D=8		KEL1055A	KIT 10 UDS REDUCCION INTERMEDIA Ø10-Ø	<table border="1"> <thead> <tr> <th>Código</th> <th>Descripción</th> <th>Cant.</th> <th>UdM</th> </tr> </thead> <tbody> <tr> <td>EL1055A0</td> <td>RACOR J.G. DE D=10 A D=8</td> <td>10</td> <td>PZ</td> </tr> </tbody> </table>	Código	Descripción	Cant.	UdM	EL1055A0	RACOR J.G. DE D=10 A D=8	10	PZ																				
Código	Descripción	Cant.	UdM																														
EL1055A0	RACOR J.G. DE D=10 A D=8	10	PZ																														

COMPONENTE			REPUESTO										
Código	Descripción	Imagen	Código	Descripción	Lista de componentes								
VL1047A	SOPORTE TUBO D6 - D8 EXTREMO J.G.		KVL1047A	KIT 10 UDS SOPORTE TUBO Ø6+TERMINAL JGØ8	<table border="1"> <thead> <tr> <th>Código</th> <th>Descripción</th> <th>Cant.</th> <th>UdM</th> </tr> </thead> <tbody> <tr> <td>VL1047A1</td> <td>SOPORTE TUBO D6 - D8 EXTREMO J.G.</td> <td>10</td> <td>PZ</td> </tr> </tbody> </table>	Código	Descripción	Cant.	UdM	VL1047A1	SOPORTE TUBO D6 - D8 EXTREMO J.G.	10	PZ
Código	Descripción	Cant.	UdM										
VL1047A1	SOPORTE TUBO D6 - D8 EXTREMO J.G.	10	PZ										
TB1098A			TB1098A0										
RC1170A	TUERCA M=14 H=8 CH=22 INOX		KRC1170A	KIT 10 TUERCAS M14 H8 CH22	<table border="1"> <thead> <tr> <th>Código</th> <th>Descripción</th> <th>Cant.</th> <th>UdM</th> </tr> </thead> <tbody> <tr> <td>RC1170A1</td> <td>TUERCA M=14 H=8 CH=22 INOX</td> <td>10</td> <td>PZ</td> </tr> </tbody> </table>	Código	Descripción	Cant.	UdM	RC1170A1	TUERCA M=14 H=8 CH=22 INOX	10	PZ
Código	Descripción	Cant.	UdM										
RC1170A1	TUERCA M=14 H=8 CH=22 INOX	10	PZ										
EL1251A			KEL1251A	KIT ELECTROVALVULA 1 VIA J.G. D8-D	<table border="1"> <thead> <tr> <th>Código</th> <th>Descripción</th> <th>Cant.</th> <th>UdM</th> </tr> </thead> <tbody> <tr> <td>EL1251A0</td> <td></td> <td>1</td> <td>PZ</td> </tr> </tbody> </table>	Código	Descripción	Cant.	UdM	EL1251A0		1	PZ
Código	Descripción	Cant.	UdM										
EL1251A0		1	PZ										
TB1132A			TB1132A0										

COMPONENTE			REPUESTO																										
Código	Descripción	Imagen	Código	Descripción	Lista de componentes																								
EL1020A			KEL1020A	KIT 10 UDS RACOR T Ø8 EL1020A	<table border="1"> <thead> <tr> <th>Código</th> <th>Descripción</th> <th>Cant.</th> <th>UdM</th> </tr> </thead> <tbody> <tr> <td>EL1020A0</td> <td>RACOR INTERMEDIO "T" TUBO Ø8</td> <td>10</td> <td>PZ</td> </tr> </tbody> </table>	Código	Descripción	Cant.	UdM	EL1020A0	RACOR INTERMEDIO "T" TUBO Ø8	10	PZ																
Código	Descripción	Cant.	UdM																										
EL1020A0	RACOR INTERMEDIO "T" TUBO Ø8	10	PZ																										
VM1820A			KVM1820A	KIT 10 TRINCHETES CROMADOS SERIE 5	<table border="1"> <thead> <tr> <th>Código</th> <th>Descripción</th> <th>Cant.</th> <th>UdM</th> </tr> </thead> <tbody> <tr> <td>VM1820A0</td> <td></td> <td>10</td> <td>PZ</td> </tr> </tbody> </table>	Código	Descripción	Cant.	UdM	VM1820A0		10	PZ																
Código	Descripción	Cant.	UdM																										
VM1820A0		10	PZ																										
GRL1335A			GRL1335A0																										
GRL1336A			GRL1336A0																										
GN1285A	GOMA SONDA TEMPERATURA NTC		KTR1106A	KIT SONDA TEMPERATURA L2000	<table border="1"> <thead> <tr> <th>Código</th> <th>Descripción</th> <th>Cant.</th> <th>UdM</th> </tr> </thead> <tbody> <tr> <td>GN1285A0</td> <td>GOMA SONDA TEMPERATUR A NTC</td> <td>1</td> <td>PZ</td> </tr> <tr> <td>SL1045A0</td> <td>SILICONA ANTRACITA S53 SP-5007 80ML</td> <td>1</td> <td>PZ</td> </tr> <tr> <td>TR1106A3</td> <td>SONDA TEMPERATUR A PT100 L2000</td> <td>1</td> <td>PZ</td> </tr> <tr> <td>VI1220A1</td> <td>VITE AUTOFIL. 4.2X12 TCB MARUTEX</td> <td>2</td> <td>PZ</td> </tr> <tr> <td>VM1465A0</td> <td>TAPA SONDA TEMPERATUR A CHEFTOP</td> <td>1</td> <td>PZ</td> </tr> </tbody> </table>	Código	Descripción	Cant.	UdM	GN1285A0	GOMA SONDA TEMPERATUR A NTC	1	PZ	SL1045A0	SILICONA ANTRACITA S53 SP-5007 80ML	1	PZ	TR1106A3	SONDA TEMPERATUR A PT100 L2000	1	PZ	VI1220A1	VITE AUTOFIL. 4.2X12 TCB MARUTEX	2	PZ	VM1465A0	TAPA SONDA TEMPERATUR A CHEFTOP	1	PZ
Código	Descripción	Cant.	UdM																										
GN1285A0	GOMA SONDA TEMPERATUR A NTC	1	PZ																										
SL1045A0	SILICONA ANTRACITA S53 SP-5007 80ML	1	PZ																										
TR1106A3	SONDA TEMPERATUR A PT100 L2000	1	PZ																										
VI1220A1	VITE AUTOFIL. 4.2X12 TCB MARUTEX	2	PZ																										
VM1465A0	TAPA SONDA TEMPERATUR A CHEFTOP	1	PZ																										

COMPONENTE			REPUESTO																														
Código	Descripción	Imagen	Código	Descripción	Lista de componentes																												
GN1285A	GOMA SONDA TEMPERATURA NTC		KTR1105A	KIT SONDA TEMPERATURA L1000	<table border="1"> <thead> <tr> <th>Código</th> <th>Descripción</th> <th>Cant.</th> <th>UdM</th> </tr> </thead> <tbody> <tr> <td>GN1120A0</td> <td>GOMA SONDA TEMPERATUR</td> <td>1</td> <td>PZ</td> </tr> <tr> <td>GN1285A0</td> <td>GOMA SONDA TEMPERATUR A NTC</td> <td>1</td> <td>PZ</td> </tr> <tr> <td>SL1045A0</td> <td>SILICONA ANTRACITA S53 SP-5007 80ML</td> <td>1</td> <td>PZ</td> </tr> <tr> <td>TR1105A3</td> <td>SONDA TEMPERATUR A PT100 L1000</td> <td>1</td> <td>PZ</td> </tr> <tr> <td>VI1220A1</td> <td>VITE AUTOFIL. 4.2X12 TCB MARUTEX</td> <td>2</td> <td>PZ</td> </tr> <tr> <td>VM1465A0</td> <td>TAPA SONDA TEMPERATUR A CHEFTOP</td> <td>1</td> <td>PZ</td> </tr> </tbody> </table>	Código	Descripción	Cant.	UdM	GN1120A0	GOMA SONDA TEMPERATUR	1	PZ	GN1285A0	GOMA SONDA TEMPERATUR A NTC	1	PZ	SL1045A0	SILICONA ANTRACITA S53 SP-5007 80ML	1	PZ	TR1105A3	SONDA TEMPERATUR A PT100 L1000	1	PZ	VI1220A1	VITE AUTOFIL. 4.2X12 TCB MARUTEX	2	PZ	VM1465A0	TAPA SONDA TEMPERATUR A CHEFTOP	1	PZ
			Código	Descripción	Cant.	UdM																											
			GN1120A0	GOMA SONDA TEMPERATUR	1	PZ																											
GN1285A0	GOMA SONDA TEMPERATUR A NTC	1	PZ																														
SL1045A0	SILICONA ANTRACITA S53 SP-5007 80ML	1	PZ																														
TR1105A3	SONDA TEMPERATUR A PT100 L1000	1	PZ																														
VI1220A1	VITE AUTOFIL. 4.2X12 TCB MARUTEX	2	PZ																														
VM1465A0	TAPA SONDA TEMPERATUR A CHEFTOP	1	PZ																														
KTR1096A	KIT SONDA TEMPERATURA L=1500 TR196A0	<table border="1"> <thead> <tr> <th>Código</th> <th>Descripción</th> <th>Cant.</th> <th>UdM</th> </tr> </thead> <tbody> <tr> <td>GN1120A0</td> <td>GOMA SONDA TEMPERATUR</td> <td>1</td> <td>PZ</td> </tr> <tr> <td>GN1285A0</td> <td>GOMA SONDA TEMPERATUR A NTC</td> <td>2</td> <td>PZ</td> </tr> <tr> <td>SL1045A0</td> <td>SILICONA ANTRACITA S53 SP-5007 80ML</td> <td>1</td> <td>PZ</td> </tr> <tr> <td>TR1096A0</td> <td></td> <td>1</td> <td>PZ</td> </tr> <tr> <td>VI1220A1</td> <td>VITE AUTOFIL. 4.2X12 TCB MARUTEX</td> <td>2</td> <td>PZ</td> </tr> <tr> <td>VM1465A0</td> <td>TAPA SONDA TEMPERATUR A CHEFTOP</td> <td>1</td> <td>PZ</td> </tr> </tbody> </table>	Código	Descripción	Cant.	UdM	GN1120A0	GOMA SONDA TEMPERATUR	1	PZ	GN1285A0	GOMA SONDA TEMPERATUR A NTC	2	PZ	SL1045A0	SILICONA ANTRACITA S53 SP-5007 80ML	1	PZ	TR1096A0		1	PZ	VI1220A1	VITE AUTOFIL. 4.2X12 TCB MARUTEX	2	PZ	VM1465A0	TAPA SONDA TEMPERATUR A CHEFTOP	1	PZ			
Código	Descripción	Cant.	UdM																														
GN1120A0	GOMA SONDA TEMPERATUR	1	PZ																														
GN1285A0	GOMA SONDA TEMPERATUR A NTC	2	PZ																														
SL1045A0	SILICONA ANTRACITA S53 SP-5007 80ML	1	PZ																														
TR1096A0		1	PZ																														
VI1220A1	VITE AUTOFIL. 4.2X12 TCB MARUTEX	2	PZ																														
VM1465A0	TAPA SONDA TEMPERATUR A CHEFTOP	1	PZ																														
KTR1095A	KIT SONDA TEMPERATURA TR1095A0	<table border="1"> <thead> <tr> <th>Código</th> <th>Descripción</th> <th>Cant.</th> <th>UdM</th> </tr> </thead> <tbody> <tr> <td>GN1120A0</td> <td>GOMA SONDA TEMPERATUR</td> <td>1</td> <td>PZ</td> </tr> <tr> <td>GN1285A0</td> <td>GOMA SONDA TEMPERATUR A NTC</td> <td>1</td> <td>PZ</td> </tr> <tr> <td>SL1045A0</td> <td>SILICONA ANTRACITA S53 SP-5007 80ML</td> <td>1</td> <td>PZ</td> </tr> <tr> <td>TR1095A0</td> <td>TEMPERATUR E PROBE NTC 150 L=1050</td> <td>1</td> <td>PZ</td> </tr> <tr> <td>VI1220A1</td> <td>VITE AUTOFIL. 4.2X12 TCB MARUTEX</td> <td>2</td> <td>PZ</td> </tr> <tr> <td>VM1465A0</td> <td>TAPA SONDA TEMPERATUR A CHEFTOP</td> <td>1</td> <td>PZ</td> </tr> </tbody> </table>	Código	Descripción	Cant.	UdM	GN1120A0	GOMA SONDA TEMPERATUR	1	PZ	GN1285A0	GOMA SONDA TEMPERATUR A NTC	1	PZ	SL1045A0	SILICONA ANTRACITA S53 SP-5007 80ML	1	PZ	TR1095A0	TEMPERATUR E PROBE NTC 150 L=1050	1	PZ	VI1220A1	VITE AUTOFIL. 4.2X12 TCB MARUTEX	2	PZ	VM1465A0	TAPA SONDA TEMPERATUR A CHEFTOP	1	PZ			
Código	Descripción	Cant.	UdM																														
GN1120A0	GOMA SONDA TEMPERATUR	1	PZ																														
GN1285A0	GOMA SONDA TEMPERATUR A NTC	1	PZ																														
SL1045A0	SILICONA ANTRACITA S53 SP-5007 80ML	1	PZ																														
TR1095A0	TEMPERATUR E PROBE NTC 150 L=1050	1	PZ																														
VI1220A1	VITE AUTOFIL. 4.2X12 TCB MARUTEX	2	PZ																														
VM1465A0	TAPA SONDA TEMPERATUR A CHEFTOP	1	PZ																														

COMPONENTE			REPUESTO																														
Código	Descripción	Imagen	Código	Descripción	Lista de componentes																												
GN1285A	GOMA SONDA TEMPERATURA NTC		KTR1002A		<table border="1"> <thead> <tr> <th>Código</th> <th>Descripción</th> <th>Cant.</th> <th>UdM</th> </tr> </thead> <tbody> <tr> <td>GN1285A0</td> <td>GOMA SONDA TEMPERATUR A NTC</td> <td>2</td> <td>PZ</td> </tr> <tr> <td>SL1045A0</td> <td>SILICONA ANTRACITA S53 SP-5007 80ML</td> <td>1</td> <td>PZ</td> </tr> <tr> <td>TR1002A0</td> <td></td> <td>1</td> <td>PZ</td> </tr> <tr> <td>VI1220A1</td> <td>VITE AUTOFIL. 4.2X12 TCB MARUTEX</td> <td>2</td> <td>PZ</td> </tr> <tr> <td>VM1465A0</td> <td>TAPA SONDA TEMPERATUR A CHEFTOP</td> <td>1</td> <td>PZ</td> </tr> </tbody> </table>	Código	Descripción	Cant.	UdM	GN1285A0	GOMA SONDA TEMPERATUR A NTC	2	PZ	SL1045A0	SILICONA ANTRACITA S53 SP-5007 80ML	1	PZ	TR1002A0		1	PZ	VI1220A1	VITE AUTOFIL. 4.2X12 TCB MARUTEX	2	PZ	VM1465A0	TAPA SONDA TEMPERATUR A CHEFTOP	1	PZ				
Código	Descripción	Cant.	UdM																														
GN1285A0	GOMA SONDA TEMPERATUR A NTC	2	PZ																														
SL1045A0	SILICONA ANTRACITA S53 SP-5007 80ML	1	PZ																														
TR1002A0		1	PZ																														
VI1220A1	VITE AUTOFIL. 4.2X12 TCB MARUTEX	2	PZ																														
VM1465A0	TAPA SONDA TEMPERATUR A CHEFTOP	1	PZ																														
VM1465A	TAPA SONDA TEMPERATURA CHEFTOP		VM1465A0	TAPA SONDA TEMPERATURA CHEFTOP																													
TR1105A	SONDA TEMPERATURA PT100 L1000		KTR1105A	KIT SONDA TEMPERATURA L1000	<table border="1"> <thead> <tr> <th>Código</th> <th>Descripción</th> <th>Cant.</th> <th>UdM</th> </tr> </thead> <tbody> <tr> <td>GN1120A0</td> <td>GOMA SONDA TEMPERATUR</td> <td>1</td> <td>PZ</td> </tr> <tr> <td>GN1285A0</td> <td>GOMA SONDA TEMPERATUR A NTC</td> <td>1</td> <td>PZ</td> </tr> <tr> <td>SL1045A0</td> <td>SILICONA ANTRACITA S53 SP-5007 80ML</td> <td>1</td> <td>PZ</td> </tr> <tr> <td>TR1105A3</td> <td>SONDA TEMPERATUR A PT100 L1000</td> <td>1</td> <td>PZ</td> </tr> <tr> <td>VI1220A1</td> <td>VITE AUTOFIL. 4.2X12 TCB MARUTEX</td> <td>2</td> <td>PZ</td> </tr> <tr> <td>VM1465A0</td> <td>TAPA SONDA TEMPERATUR A CHEFTOP</td> <td>1</td> <td>PZ</td> </tr> </tbody> </table>	Código	Descripción	Cant.	UdM	GN1120A0	GOMA SONDA TEMPERATUR	1	PZ	GN1285A0	GOMA SONDA TEMPERATUR A NTC	1	PZ	SL1045A0	SILICONA ANTRACITA S53 SP-5007 80ML	1	PZ	TR1105A3	SONDA TEMPERATUR A PT100 L1000	1	PZ	VI1220A1	VITE AUTOFIL. 4.2X12 TCB MARUTEX	2	PZ	VM1465A0	TAPA SONDA TEMPERATUR A CHEFTOP	1	PZ
Código	Descripción	Cant.	UdM																														
GN1120A0	GOMA SONDA TEMPERATUR	1	PZ																														
GN1285A0	GOMA SONDA TEMPERATUR A NTC	1	PZ																														
SL1045A0	SILICONA ANTRACITA S53 SP-5007 80ML	1	PZ																														
TR1105A3	SONDA TEMPERATUR A PT100 L1000	1	PZ																														
VI1220A1	VITE AUTOFIL. 4.2X12 TCB MARUTEX	2	PZ																														
VM1465A0	TAPA SONDA TEMPERATUR A CHEFTOP	1	PZ																														
GN1421A	GOMA PUERTA XFT200 - GN1006A		KG1421A	KIT GOMA PUERTA XFT200	<table border="1"> <thead> <tr> <th>Código</th> <th>Descripción</th> <th>Cant.</th> <th>UdM</th> </tr> </thead> <tbody> <tr> <td>GN1006A1</td> <td>GOMA DE PUERTA</td> <td>1.890</td> <td>M</td> </tr> <tr> <td>GN1008A0</td> <td>GOMA INTERNA PARA CONEXION GN1006</td> <td>0.030</td> <td>M</td> </tr> </tbody> </table>	Código	Descripción	Cant.	UdM	GN1006A1	GOMA DE PUERTA	1.890	M	GN1008A0	GOMA INTERNA PARA CONEXION GN1006	0.030	M																
Código	Descripción	Cant.	UdM																														
GN1006A1	GOMA DE PUERTA	1.890	M																														
GN1008A0	GOMA INTERNA PARA CONEXION GN1006	0.030	M																														



COMPONENTE			REPUESTO					
Código	Descripción	Imagen	Código	Descripción	Lista de componentes			
GN1421A	GOMA PUERTA XFT200 - GN1006A		KGN1421A	KIT GOMA PUERTA XFT200	Código	Descripción	Cant.	UdM
					SL1025A0	SILICONA 90ML DOW CORNING 734 CLEAR	0.012	PZ
					VM2277A0	CONEXION INTERNA GOMA PUERT	1	PZ

ASM1444A/0.D03 - Cobertura exterior

ANVERSO

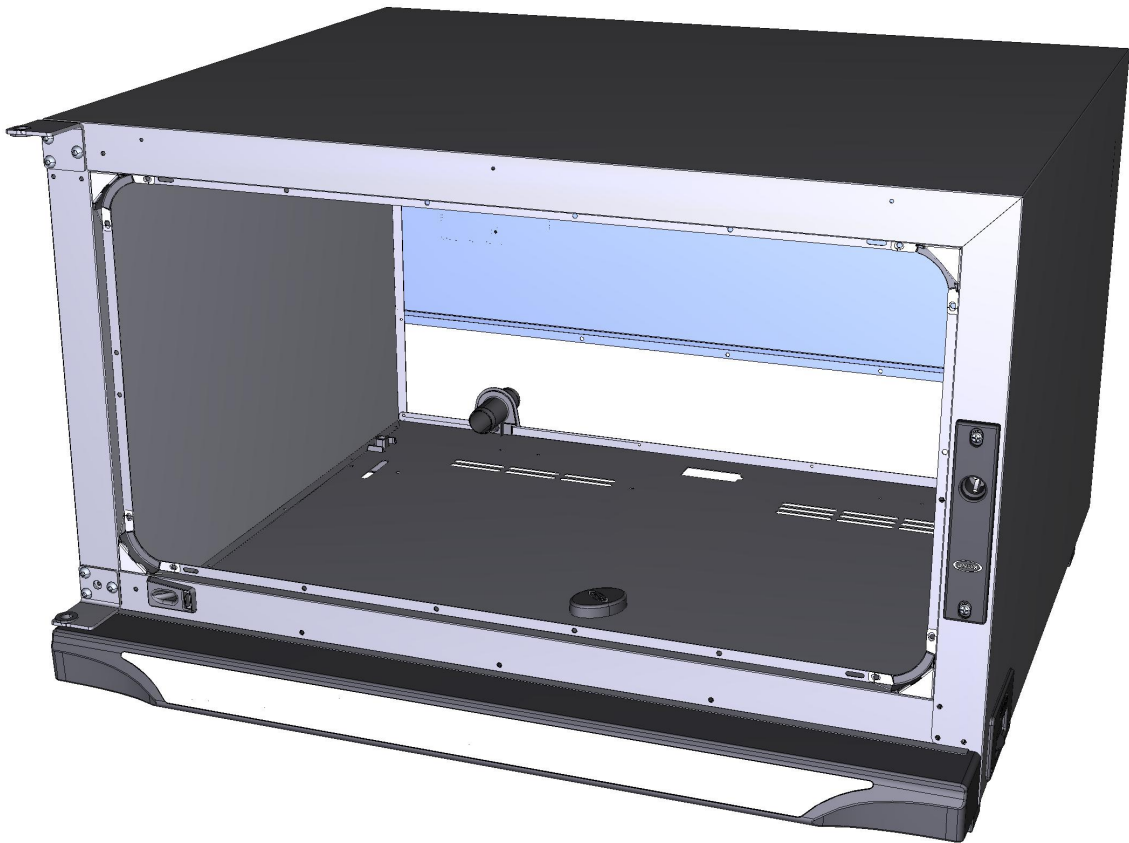





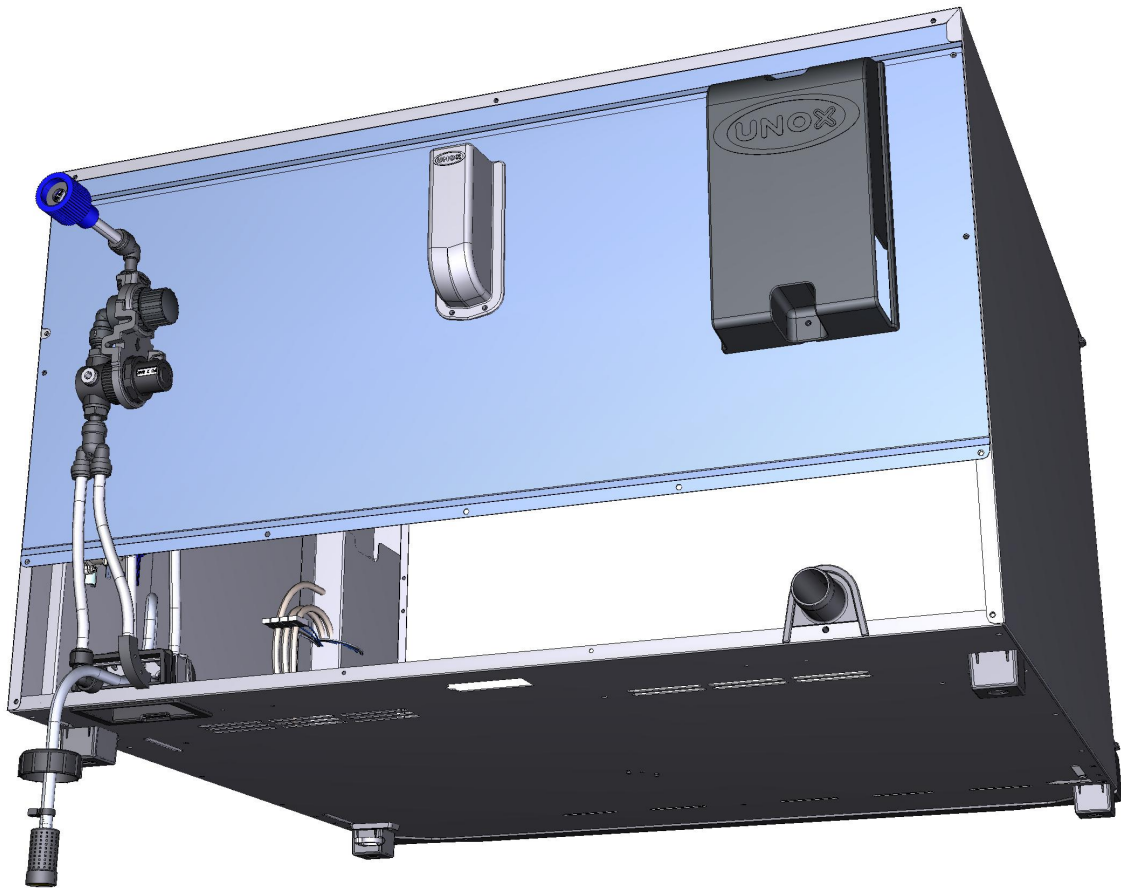



ASM1444A/0.D03 - Cobertura exterior

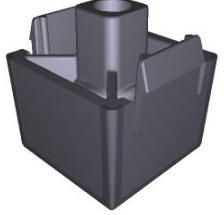

REVERSO



COMPONENTE			REPUESTO														
Código	Descripción	Imagen	Código	Descripción	Lista de componentes												
0D1998B	CARCASA PARA LINE MISS TOP ROSSELLA		0D1998B2	CARCASA PARA LINE MISS TOP ROSSELLA													
VM1951A			KVM1065A	COFIA PLASTICO CUBRE CONDUCTO CHIMENEA	<table border="1"> <thead> <tr> <th>Código</th> <th>Descripción</th> <th>Cant.</th> <th>UdM</th> </tr> </thead> <tbody> <tr> <td>VM1065A0</td> <td>COFIA PLASTICO CUBRE CONDUCTO CHIMENEA</td> <td>1</td> <td>PZ</td> </tr> </tbody> </table>	Código	Descripción	Cant.	UdM	VM1065A0	COFIA PLASTICO CUBRE CONDUCTO CHIMENEA	1	PZ				
Código	Descripción	Cant.	UdM														
VM1065A0	COFIA PLASTICO CUBRE CONDUCTO CHIMENEA	1	PZ														
CR1035A	CERRADURA ELECTROMAGNETICA L.M. STEF		KCR1035A	KIT CIERRE ELECTROMAGNETICO LMISSMATIC	<table border="1"> <thead> <tr> <th>Código</th> <th>Descripción</th> <th>Cant.</th> <th>UdM</th> </tr> </thead> <tbody> <tr> <td>CR1035A0</td> <td>CERRADURA ELECTROMAGNETICA L.M. STEF</td> <td>1</td> <td>PZ</td> </tr> </tbody> </table>	Código	Descripción	Cant.	UdM	CR1035A0	CERRADURA ELECTROMAGNETICA L.M. STEF	1	PZ				
Código	Descripción	Cant.	UdM														
CR1035A0	CERRADURA ELECTROMAGNETICA L.M. STEF	1	PZ														
VM2154A			KVM2154A		<table border="1"> <thead> <tr> <th>Código</th> <th>Descripción</th> <th>Cant.</th> <th>UdM</th> </tr> </thead> <tbody> <tr> <td>0H1234A0</td> <td></td> <td>1</td> <td>PZ</td> </tr> <tr> <td>VM2154A0</td> <td></td> <td>1</td> <td>PZ</td> </tr> </tbody> </table>	Código	Descripción	Cant.	UdM	0H1234A0		1	PZ	VM2154A0		1	PZ
Código	Descripción	Cant.	UdM														
0H1234A0		1	PZ														
VM2154A0		1	PZ														
0H1234A			KVM2154A		<table border="1"> <thead> <tr> <th>Código</th> <th>Descripción</th> <th>Cant.</th> <th>UdM</th> </tr> </thead> <tbody> <tr> <td>0H1234A0</td> <td></td> <td>1</td> <td>PZ</td> </tr> <tr> <td>VM2154A0</td> <td></td> <td>1</td> <td>PZ</td> </tr> </tbody> </table>	Código	Descripción	Cant.	UdM	0H1234A0		1	PZ	VM2154A0		1	PZ
Código	Descripción	Cant.	UdM														
0H1234A0		1	PZ														
VM2154A0		1	PZ														

COMPONENTE			REPUESTO																		
Código	Descripción	Imagen	Código	Descripción	Lista de componentes																
CE1295A			KCE1295A		<table border="1"> <thead> <tr> <th>Código</th> <th>Descripción</th> <th>Cant.</th> <th>UdM</th> </tr> </thead> <tbody> <tr> <td>CE1295A1</td> <td></td> <td>1</td> <td>PZ</td> </tr> </tbody> </table>	Código	Descripción	Cant.	UdM	CE1295A1		1	PZ								
Código	Descripción	Cant.	UdM																		
CE1295A1		1	PZ																		
0H1236B	CONDUCTO VENTILACION CIERRE ARI-ROS TO		0H1236B2	CONDUCTO VENTILACION CIERRE ARI-ROS TO																	
0H1450A	ESQUINA FRONTAL CAMARA INOX XB-XV-XG		0H1450A0	ESQUINA FRONTAL CAMARA INOX XB-XV-XG																	
PD1001A	PATA 35X35 H26 PLASTICO+GOMA GRISA		KPD1001A	KIT 4 PATAS 35X35 H26 PD1001A0	<table border="1"> <thead> <tr> <th>Código</th> <th>Descripción</th> <th>Cant.</th> <th>UdM</th> </tr> </thead> <tbody> <tr> <td>PD1001A0</td> <td>PATA 35X35 H26 PLASTICO+GO MA GRISA</td> <td>4</td> <td>PZ</td> </tr> </tbody> </table>	Código	Descripción	Cant.	UdM	PD1001A0	PATA 35X35 H26 PLASTICO+GO MA GRISA	4	PZ								
Código	Descripción	Cant.	UdM																		
PD1001A0	PATA 35X35 H26 PLASTICO+GO MA GRISA	4	PZ																		
0H1222B	BISAGRA INFERIOR PUERTA LINE MISS TOP		K0H1222A		<table border="1"> <thead> <tr> <th>Código</th> <th>Descripción</th> <th>Cant.</th> <th>UdM</th> </tr> </thead> <tbody> <tr> <td>0H1222A0</td> <td></td> <td>1</td> <td>PZ</td> </tr> <tr> <td>VI1780A0</td> <td></td> <td>3</td> <td>PZ</td> </tr> <tr> <td>VM2003A0</td> <td></td> <td>1</td> <td>PZ</td> </tr> </tbody> </table>	Código	Descripción	Cant.	UdM	0H1222A0		1	PZ	VI1780A0		3	PZ	VM2003A0		1	PZ
Código	Descripción	Cant.	UdM																		
0H1222A0		1	PZ																		
VI1780A0		3	PZ																		
VM2003A0		1	PZ																		



COMPONENTE			REPUESTO																		
Código	Descripción	Imagen	Código	Descripción	Lista de componentes																
0H2665A	CONTRAESTRIBO INFERIOR PUERTA L.MISS TOP		0H2665A1	CONTRAESTRIBO INFERIOR PUERTA L.MISS TOP																	
VM2003A			KVM2003A	KIT 10 CASQUILLOS PUERTA VM2003A0	<table border="1"> <thead> <tr> <th>Código</th> <th>Descripción</th> <th>Cant.</th> <th>UdM</th> </tr> </thead> <tbody> <tr> <td>VM2003A0</td> <td></td> <td>10</td> <td>PZ</td> </tr> </tbody> </table>	Código	Descripción	Cant.	UdM	VM2003A0		10	PZ								
Código	Descripción	Cant.	UdM																		
VM2003A0		10	PZ																		
VM2003A			KVM2003A	KIT 10 CASQUILLOS PUERTA VM2003A0	<table border="1"> <thead> <tr> <th>Código</th> <th>Descripción</th> <th>Cant.</th> <th>UdM</th> </tr> </thead> <tbody> <tr> <td>VM2003A0</td> <td></td> <td>10</td> <td>PZ</td> </tr> </tbody> </table>	Código	Descripción	Cant.	UdM	VM2003A0		10	PZ								
Código	Descripción	Cant.	UdM																		
VM2003A0		10	PZ																		
0H1221A	BISAGRA SUPERIOR PUERTA LINE MISS TOP		K0H1221A		<table border="1"> <thead> <tr> <th>Código</th> <th>Descripción</th> <th>Cant.</th> <th>UdM</th> </tr> </thead> <tbody> <tr> <td>0H1221A1</td> <td>BISAGRA SUPERIOR PUERTA LINE MISS TOP</td> <td>1</td> <td>PZ</td> </tr> <tr> <td>VI1780A0</td> <td></td> <td>3</td> <td>PZ</td> </tr> <tr> <td>VM2003A0</td> <td></td> <td>1</td> <td>PZ</td> </tr> </tbody> </table>	Código	Descripción	Cant.	UdM	0H1221A1	BISAGRA SUPERIOR PUERTA LINE MISS TOP	1	PZ	VI1780A0		3	PZ	VM2003A0		1	PZ
Código	Descripción	Cant.	UdM																		
0H1221A1	BISAGRA SUPERIOR PUERTA LINE MISS TOP	1	PZ																		
VI1780A0		3	PZ																		
VM2003A0		1	PZ																		
0H2666B	CONTRAESTRIBO SUP.IZ. PUERTA LM MATIC-TO		0H2666B1	CONTRAESTRIBO SUP.IZ. PUERTA LM MATIC-TO																	

COMPONENTE			REPUESTO																																		
Código	Descripción	Imagen	Código	Descripción	Lista de componentes																																
PE2012A	CONJUNTO UNOXLINK LINE MISS RJ45		KPE2012A	KIT UNOX.LINK USB LINEMISS RJ45	<table border="1"> <thead> <tr> <th>Código</th> <th>Descripción</th> <th>Cant.</th> <th>UdM</th> </tr> </thead> <tbody> <tr> <td>PE2012A0</td> <td>CONJUNTO UNOXLINK LINE MISS RJ4</td> <td>1</td> <td>PZ</td> </tr> <tr> <td>VI1960A0</td> <td></td> <td>4</td> <td>PZ</td> </tr> </tbody> </table>	Código	Descripción	Cant.	UdM	PE2012A0	CONJUNTO UNOXLINK LINE MISS RJ4	1	PZ	VI1960A0		4	PZ																				
Código	Descripción	Cant.	UdM																																		
PE2012A0	CONJUNTO UNOXLINK LINE MISS RJ4	1	PZ																																		
VI1960A0		4	PZ																																		
CE1012A	CABLE RJ45 L= 1 MT		KVM2190A		<table border="1"> <thead> <tr> <th>Código</th> <th>Descripción</th> <th>Cant.</th> <th>UdM</th> </tr> </thead> <tbody> <tr> <td>MS1014A1</td> <td>ETIQUETA PANEL CONTROL MATIC LM600 TOUCH</td> <td>1</td> <td>PZ</td> </tr> <tr> <td>PE2018B0</td> <td>TARJETA DE CONTROL LMISS TOUCH</td> <td>1</td> <td>PZ</td> </tr> <tr> <td>VI1635A0</td> <td>TORNILLO M4X8 TSP+ ZINCATO</td> <td>5</td> <td>PZ</td> </tr> <tr> <td>VM1794A0</td> <td>ABRAZADERA NEGRA 250X4.8 PA66</td> <td>2</td> <td>PZ</td> </tr> <tr> <td>VM2016A0</td> <td>PANEL DE CONTROL DYNAMIC LMISS 46X33</td> <td>1</td> <td>PZ</td> </tr> <tr> <td>VM2103A0</td> <td>PLAQUETA FIJA ABRAZADERA</td> <td>2</td> <td>PZ</td> </tr> </tbody> </table>	Código	Descripción	Cant.	UdM	MS1014A1	ETIQUETA PANEL CONTROL MATIC LM600 TOUCH	1	PZ	PE2018B0	TARJETA DE CONTROL LMISS TOUCH	1	PZ	VI1635A0	TORNILLO M4X8 TSP+ ZINCATO	5	PZ	VM1794A0	ABRAZADERA NEGRA 250X4.8 PA66	2	PZ	VM2016A0	PANEL DE CONTROL DYNAMIC LMISS 46X33	1	PZ	VM2103A0	PLAQUETA FIJA ABRAZADERA	2	PZ				
Código	Descripción	Cant.	UdM																																		
MS1014A1	ETIQUETA PANEL CONTROL MATIC LM600 TOUCH	1	PZ																																		
PE2018B0	TARJETA DE CONTROL LMISS TOUCH	1	PZ																																		
VI1635A0	TORNILLO M4X8 TSP+ ZINCATO	5	PZ																																		
VM1794A0	ABRAZADERA NEGRA 250X4.8 PA66	2	PZ																																		
VM2016A0	PANEL DE CONTROL DYNAMIC LMISS 46X33	1	PZ																																		
VM2103A0	PLAQUETA FIJA ABRAZADERA	2	PZ																																		
			KVM2186A	KIT CONTROL COMPLETO LM MATIC-TOP 46X33	<table border="1"> <thead> <tr> <th>Código</th> <th>Descripción</th> <th>Cant.</th> <th>UdM</th> </tr> </thead> <tbody> <tr> <td>CE1012A0</td> <td>CABLE RJ45 L= 1 MT</td> <td>1</td> <td>PZ</td> </tr> <tr> <td>MS1014A0</td> <td></td> <td>1</td> <td>PZ</td> </tr> <tr> <td>PE1980B0</td> <td>CONJUNTO TARJETA CONTROL LMISS TOUCH</td> <td>1</td> <td>PZ</td> </tr> <tr> <td>VI1635A0</td> <td>TORNILLO M4X8 TSP+ ZINCATO</td> <td>5</td> <td>PZ</td> </tr> <tr> <td>VM1794A0</td> <td>ABRAZADERA NEGRA 250X4.8 PA66</td> <td>2</td> <td>PZ</td> </tr> <tr> <td>VM2016A0</td> <td>PANEL DE CONTROL DYNAMIC LMISS 46X33</td> <td>1</td> <td>PZ</td> </tr> <tr> <td>VM2103A0</td> <td>PLAQUETA FIJA ABRAZADERA</td> <td>2</td> <td>PZ</td> </tr> </tbody> </table>	Código	Descripción	Cant.	UdM	CE1012A0	CABLE RJ45 L= 1 MT	1	PZ	MS1014A0		1	PZ	PE1980B0	CONJUNTO TARJETA CONTROL LMISS TOUCH	1	PZ	VI1635A0	TORNILLO M4X8 TSP+ ZINCATO	5	PZ	VM1794A0	ABRAZADERA NEGRA 250X4.8 PA66	2	PZ	VM2016A0	PANEL DE CONTROL DYNAMIC LMISS 46X33	1	PZ	VM2103A0	PLAQUETA FIJA ABRAZADERA	2	PZ
Código	Descripción	Cant.	UdM																																		
CE1012A0	CABLE RJ45 L= 1 MT	1	PZ																																		
MS1014A0		1	PZ																																		
PE1980B0	CONJUNTO TARJETA CONTROL LMISS TOUCH	1	PZ																																		
VI1635A0	TORNILLO M4X8 TSP+ ZINCATO	5	PZ																																		
VM1794A0	ABRAZADERA NEGRA 250X4.8 PA66	2	PZ																																		
VM2016A0	PANEL DE CONTROL DYNAMIC LMISS 46X33	1	PZ																																		
VM2103A0	PLAQUETA FIJA ABRAZADERA	2	PZ																																		

COMPONENTE			REPUESTO																																		
Código	Descripción	Imagen	Código	Descripción	Lista de componentes																																
CE1012A	CABLE RJ45 L= 1 MT		KVM2185A	KIT CONTROL COMPLETO LMISS DYNAMIC 46X33	<table border="1"> <thead> <tr> <th>Código</th> <th>Descripción</th> <th>Cant.</th> <th>UdM</th> </tr> </thead> <tbody> <tr> <td>CE1012A0</td> <td>CABLE RJ45 L= 1 MT</td> <td>1</td> <td>PZ</td> </tr> <tr> <td>MS1012A0</td> <td></td> <td>1</td> <td>PZ</td> </tr> <tr> <td>PE1980B0</td> <td>CONJUNTO TARJETA CONTROL LMISS TOUCH</td> <td>1</td> <td>PZ</td> </tr> <tr> <td>VI1635A0</td> <td>TORNILLO M4X8 TSP+ ZINCATO</td> <td>5</td> <td>PZ</td> </tr> <tr> <td>VM1794A0</td> <td>ABRAZADERA NEGRA 250X4.8 PA66</td> <td>2</td> <td>PZ</td> </tr> <tr> <td>VM2016A0</td> <td>PANEL DE CONTROL DYNAMIC LMISS 46X33</td> <td>1</td> <td>PZ</td> </tr> <tr> <td>VM2103A0</td> <td>PLAQUETA FIJA ABRAZADERA</td> <td>2</td> <td>PZ</td> </tr> </tbody> </table>	Código	Descripción	Cant.	UdM	CE1012A0	CABLE RJ45 L= 1 MT	1	PZ	MS1012A0		1	PZ	PE1980B0	CONJUNTO TARJETA CONTROL LMISS TOUCH	1	PZ	VI1635A0	TORNILLO M4X8 TSP+ ZINCATO	5	PZ	VM1794A0	ABRAZADERA NEGRA 250X4.8 PA66	2	PZ	VM2016A0	PANEL DE CONTROL DYNAMIC LMISS 46X33	1	PZ	VM2103A0	PLAQUETA FIJA ABRAZADERA	2	PZ
			Código	Descripción	Cant.	UdM																															
			CE1012A0	CABLE RJ45 L= 1 MT	1	PZ																															
MS1012A0		1	PZ																																		
PE1980B0	CONJUNTO TARJETA CONTROL LMISS TOUCH	1	PZ																																		
VI1635A0	TORNILLO M4X8 TSP+ ZINCATO	5	PZ																																		
VM1794A0	ABRAZADERA NEGRA 250X4.8 PA66	2	PZ																																		
VM2016A0	PANEL DE CONTROL DYNAMIC LMISS 46X33	1	PZ																																		
VM2103A0	PLAQUETA FIJA ABRAZADERA	2	PZ																																		
KVM2184A	KIT CONTROL COMPLETO LMISS CLASSIC 46X33	<table border="1"> <thead> <tr> <th>Código</th> <th>Descripción</th> <th>Cant.</th> <th>UdM</th> </tr> </thead> <tbody> <tr> <td>CE1012A0</td> <td>CABLE RJ45 L= 1 MT</td> <td>1</td> <td>PZ</td> </tr> <tr> <td>MS1016A0</td> <td></td> <td>1</td> <td>PZ</td> </tr> <tr> <td>PE1980B0</td> <td>CONJUNTO TARJETA CONTROL LMISS TOUCH</td> <td>1</td> <td>PZ</td> </tr> <tr> <td>VI1635A0</td> <td>TORNILLO M4X8 TSP+ ZINCATO</td> <td>5</td> <td>PZ</td> </tr> <tr> <td>VM1794A0</td> <td>ABRAZADERA NEGRA 250X4.8 PA66</td> <td>2</td> <td>PZ</td> </tr> <tr> <td>VM2016A0</td> <td>PANEL DE CONTROL DYNAMIC LMISS 46X33</td> <td>1</td> <td>PZ</td> </tr> <tr> <td>VM2103A0</td> <td>PLAQUETA FIJA ABRAZADERA</td> <td>2</td> <td>PZ</td> </tr> </tbody> </table>	Código	Descripción	Cant.	UdM	CE1012A0	CABLE RJ45 L= 1 MT	1	PZ	MS1016A0		1	PZ	PE1980B0	CONJUNTO TARJETA CONTROL LMISS TOUCH	1	PZ	VI1635A0	TORNILLO M4X8 TSP+ ZINCATO	5	PZ	VM1794A0	ABRAZADERA NEGRA 250X4.8 PA66	2	PZ	VM2016A0	PANEL DE CONTROL DYNAMIC LMISS 46X33	1	PZ	VM2103A0	PLAQUETA FIJA ABRAZADERA	2	PZ			
Código	Descripción	Cant.	UdM																																		
CE1012A0	CABLE RJ45 L= 1 MT	1	PZ																																		
MS1016A0		1	PZ																																		
PE1980B0	CONJUNTO TARJETA CONTROL LMISS TOUCH	1	PZ																																		
VI1635A0	TORNILLO M4X8 TSP+ ZINCATO	5	PZ																																		
VM1794A0	ABRAZADERA NEGRA 250X4.8 PA66	2	PZ																																		
VM2016A0	PANEL DE CONTROL DYNAMIC LMISS 46X33	1	PZ																																		
VM2103A0	PLAQUETA FIJA ABRAZADERA	2	PZ																																		
KCE1012A	KIT CABLE RJ45 CONEXION CONTROL POTENCI	<table border="1"> <thead> <tr> <th>Código</th> <th>Descripción</th> <th>Cant.</th> <th>UdM</th> </tr> </thead> <tbody> <tr> <td>CE1012A0</td> <td>CABLE RJ45 L= 1 MT</td> <td>1</td> <td>PZ</td> </tr> </tbody> </table>	Código	Descripción	Cant.	UdM	CE1012A0	CABLE RJ45 L= 1 MT	1	PZ																											
Código	Descripción	Cant.	UdM																																		
CE1012A0	CABLE RJ45 L= 1 MT	1	PZ																																		

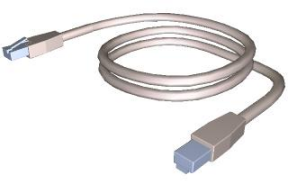

COMPONENTE			REPUESTO																																														
Código	Descripción	Imagen	Código	Descripción	Lista de componentes																																												
0E1337A	PANEL INFERIOR XFT200/L		0E1337A0	PANEL INFERIOR XFT200/L																																													
0F1096A	PANEL TRASERO LINE MISS TOP ROSSELLA		0F1096A0	PANEL TRASERO LINE MISS TOP ROSSELLA																																													
VM1008A	PERFIL INTERNO A L SOPORTE GOMA		VM1008A0	PERFIL INTERNO A L SOPORTE GOMA																																													
VM1805A	PORTA-IMAN		K0H3312A	KIT CIERRE PUERTA HORNOS SERIE 5	<table border="1"> <thead> <tr> <th>Código</th> <th>Descripción</th> <th>Cant.</th> <th>UdM</th> </tr> </thead> <tbody> <tr> <td>0H4790A0</td> <td></td> <td>1</td> <td>PZ</td> </tr> <tr> <td>0H4810A0</td> <td></td> <td>1</td> <td>PZ</td> </tr> <tr> <td>VE1030A1</td> <td>IMAN D=22,9MM PARA MICROPUERT</td> <td>2</td> <td>PZ</td> </tr> <tr> <td>VI1220A1</td> <td>VITE AUTOFIL. 4.2X12 TCB MARUTEX</td> <td>1</td> <td>PZ</td> </tr> <tr> <td>VM1805A0</td> <td>PORTA-IMAN</td> <td>1</td> <td>PZ</td> </tr> </tbody> </table>	Código	Descripción	Cant.	UdM	0H4790A0		1	PZ	0H4810A0		1	PZ	VE1030A1	IMAN D=22,9MM PARA MICROPUERT	2	PZ	VI1220A1	VITE AUTOFIL. 4.2X12 TCB MARUTEX	1	PZ	VM1805A0	PORTA-IMAN	1	PZ																				
Código	Descripción	Cant.	UdM																																														
0H4790A0		1	PZ																																														
0H4810A0		1	PZ																																														
VE1030A1	IMAN D=22,9MM PARA MICROPUERT	2	PZ																																														
VI1220A1	VITE AUTOFIL. 4.2X12 TCB MARUTEX	1	PZ																																														
VM1805A0	PORTA-IMAN	1	PZ																																														
			K0H3311A	KIT CERRADURA PUERTA PARA HORNOS SERIE 4	<table border="1"> <thead> <tr> <th>Código</th> <th>Descripción</th> <th>Cant.</th> <th>UdM</th> </tr> </thead> <tbody> <tr> <td>0H4790A0</td> <td></td> <td>1</td> <td>PZ</td> </tr> <tr> <td>0H4795A0</td> <td></td> <td>2</td> <td>PZ</td> </tr> <tr> <td>0H4805A0</td> <td></td> <td>1</td> <td>PZ</td> </tr> <tr> <td>IP1325B0</td> <td></td> <td>2</td> <td>PZ</td> </tr> <tr> <td>TB1805A0</td> <td></td> <td>2</td> <td>PZ</td> </tr> <tr> <td>VE1030A1</td> <td>IMAN D=22,9MM PARA MICROPUERT</td> <td>2</td> <td>PZ</td> </tr> <tr> <td>VI1220A0</td> <td></td> <td>1</td> <td>PZ</td> </tr> <tr> <td>VM1059A1</td> <td></td> <td>1.500</td> <td>M</td> </tr> <tr> <td>VM1805A0</td> <td>PORTA-IMAN</td> <td>1</td> <td>PZ</td> </tr> <tr> <td>VM2053A0</td> <td></td> <td>2</td> <td>PZ</td> </tr> </tbody> </table>	Código	Descripción	Cant.	UdM	0H4790A0		1	PZ	0H4795A0		2	PZ	0H4805A0		1	PZ	IP1325B0		2	PZ	TB1805A0		2	PZ	VE1030A1	IMAN D=22,9MM PARA MICROPUERT	2	PZ	VI1220A0		1	PZ	VM1059A1		1.500	M	VM1805A0	PORTA-IMAN	1	PZ	VM2053A0		2	PZ
Código	Descripción	Cant.	UdM																																														
0H4790A0		1	PZ																																														
0H4795A0		2	PZ																																														
0H4805A0		1	PZ																																														
IP1325B0		2	PZ																																														
TB1805A0		2	PZ																																														
VE1030A1	IMAN D=22,9MM PARA MICROPUERT	2	PZ																																														
VI1220A0		1	PZ																																														
VM1059A1		1.500	M																																														
VM1805A0	PORTA-IMAN	1	PZ																																														
VM2053A0		2	PZ																																														

COMPONENTE			REPUESTO																		
Código	Descripción	Imagen	Código	Descripción	Lista de componentes																
VL1022A			KVL1022A		<table border="1"> <thead> <tr> <th>Código</th> <th>Descripción</th> <th>Cant.</th> <th>UdM</th> </tr> </thead> <tbody> <tr> <td>VL1022A0</td> <td></td> <td>1</td> <td>PZ</td> </tr> </tbody> </table>	Código	Descripción	Cant.	UdM	VL1022A0		1	PZ								
Código	Descripción	Cant.	UdM																		
VL1022A0		1	PZ																		
VL1027A			KVL1027A		<table border="1"> <thead> <tr> <th>Código</th> <th>Descripción</th> <th>Cant.</th> <th>UdM</th> </tr> </thead> <tbody> <tr> <td>VL1220A1</td> <td>VITE AUTOFIL. 4.2X12 TCB MARUTEX</td> <td>2</td> <td>PZ</td> </tr> <tr> <td>VL1027A0</td> <td></td> <td>1</td> <td>PZ</td> </tr> <tr> <td>VL1028A0</td> <td></td> <td>1</td> <td>PZ</td> </tr> </tbody> </table>	Código	Descripción	Cant.	UdM	VL1220A1	VITE AUTOFIL. 4.2X12 TCB MARUTEX	2	PZ	VL1027A0		1	PZ	VL1028A0		1	PZ
Código	Descripción	Cant.	UdM																		
VL1220A1	VITE AUTOFIL. 4.2X12 TCB MARUTEX	2	PZ																		
VL1027A0		1	PZ																		
VL1028A0		1	PZ																		
VM1225A			VM1225A1																		
VM1556A	XBC-XVC COOLING FAN GUARD		KVM1556A		<table border="1"> <thead> <tr> <th>Código</th> <th>Descripción</th> <th>Cant.</th> <th>UdM</th> </tr> </thead> <tbody> <tr> <td>VM1556A0</td> <td>XBC-XVC COOLING FAN GUARD</td> <td>1</td> <td>PZ</td> </tr> </tbody> </table>	Código	Descripción	Cant.	UdM	VM1556A0	XBC-XVC COOLING FAN GUARD	1	PZ								
Código	Descripción	Cant.	UdM																		
VM1556A0	XBC-XVC COOLING FAN GUARD	1	PZ																		
VN1175A			KVN1175A		<table border="1"> <thead> <tr> <th>Código</th> <th>Descripción</th> <th>Cant.</th> <th>UdM</th> </tr> </thead> <tbody> <tr> <td>VN1175A0</td> <td></td> <td>1</td> <td>PZ</td> </tr> </tbody> </table>	Código	Descripción	Cant.	UdM	VN1175A0		1	PZ								
Código	Descripción	Cant.	UdM																		
VN1175A0		1	PZ																		

COMPONENTE			REPUESTO																														
Código	Descripción	Imagen	Código	Descripción	Lista de componentes																												
VM2189B	CONTROL COMPLETO LMISSSTOP - MATIC 60X40		KVM2189B	KIT CONTROL COMPLETO LM800 MATIC-TOP	<table border="1"> <thead> <tr> <th>Código</th> <th>Descripción</th> <th>Cant.</th> <th>UdM</th> </tr> </thead> <tbody> <tr> <td>MS1015A1</td> <td>ANTIFAZ CONTROL MATIC LM800 TOUCH</td> <td>1</td> <td>PZ</td> </tr> <tr> <td>PE1980B0</td> <td>CONJUNTO TARJETA CONTROL LMISS TOUCH</td> <td>1</td> <td>PZ</td> </tr> <tr> <td>VI1635A0</td> <td>TORNILLO M4X8 TSP+ ZINCATO</td> <td>1</td> <td>PZ</td> </tr> <tr> <td>VM1794A0</td> <td>ABRAZADERA NEGRA 250X4.8 PA66</td> <td>2</td> <td>PZ</td> </tr> <tr> <td>VM2017A0</td> <td>PANEL CONTROL DYNAMIC LMISS 600X40</td> <td>1</td> <td>PZ</td> </tr> <tr> <td>VM2103A0</td> <td>PLAQUETA FIJA ABRAZADERA</td> <td>2</td> <td>PZ</td> </tr> </tbody> </table>	Código	Descripción	Cant.	UdM	MS1015A1	ANTIFAZ CONTROL MATIC LM800 TOUCH	1	PZ	PE1980B0	CONJUNTO TARJETA CONTROL LMISS TOUCH	1	PZ	VI1635A0	TORNILLO M4X8 TSP+ ZINCATO	1	PZ	VM1794A0	ABRAZADERA NEGRA 250X4.8 PA66	2	PZ	VM2017A0	PANEL CONTROL DYNAMIC LMISS 600X40	1	PZ	VM2103A0	PLAQUETA FIJA ABRAZADERA	2	PZ
Código	Descripción	Cant.	UdM																														
MS1015A1	ANTIFAZ CONTROL MATIC LM800 TOUCH	1	PZ																														
PE1980B0	CONJUNTO TARJETA CONTROL LMISS TOUCH	1	PZ																														
VI1635A0	TORNILLO M4X8 TSP+ ZINCATO	1	PZ																														
VM1794A0	ABRAZADERA NEGRA 250X4.8 PA66	2	PZ																														
VM2017A0	PANEL CONTROL DYNAMIC LMISS 600X40	1	PZ																														
VM2103A0	PLAQUETA FIJA ABRAZADERA	2	PZ																														
CE1305A	CABLE RJ45-RJ45 L=2MT		KCE1305A	KIT KABLE RJ45 - RJ45 L=2MT	<table border="1"> <thead> <tr> <th>Código</th> <th>Descripción</th> <th>Cant.</th> <th>UdM</th> </tr> </thead> <tbody> <tr> <td>CE1305A0</td> <td>CABLE RJ45-RJ45 L=2MT</td> <td>1</td> <td>PZ</td> </tr> </tbody> </table>	Código	Descripción	Cant.	UdM	CE1305A0	CABLE RJ45-RJ45 L=2MT	1	PZ																				
Código	Descripción	Cant.	UdM																														
CE1305A0	CABLE RJ45-RJ45 L=2MT	1	PZ																														
0D1840C	PERFIL INFERIOR DELANTERO LM 600X400		0D1840C0	PERFIL INFERIOR DELANTERO LM 600X400																													
RC1365A			KRC1365A	KIT CONEXION RED DE AGUA PRINCIPA	<table border="1"> <thead> <tr> <th>Código</th> <th>Descripción</th> <th>Cant.</th> <th>UdM</th> </tr> </thead> <tbody> <tr> <td>GN1200A1</td> <td></td> <td>1</td> <td>PZ</td> </tr> <tr> <td>RC1002A0</td> <td></td> <td>1</td> <td>PZ</td> </tr> <tr> <td>RC1365A0</td> <td></td> <td>1</td> <td>PZ</td> </tr> </tbody> </table>	Código	Descripción	Cant.	UdM	GN1200A1		1	PZ	RC1002A0		1	PZ	RC1365A0		1	PZ												
Código	Descripción	Cant.	UdM																														
GN1200A1		1	PZ																														
RC1002A0		1	PZ																														
RC1365A0		1	PZ																														



COMPONENTE			REPUESTO																																		
Código	Descripción	Imagen	Código	Descripción	Lista de componentes																																
RC1006A			KRC1006A		<table border="1"> <thead> <tr> <th>Código</th> <th>Descripción</th> <th>Cant.</th> <th>UdM</th> </tr> </thead> <tbody> <tr> <td>RC1006A0</td> <td></td> <td>20</td> <td>PZ</td> </tr> </tbody> </table>	Código	Descripción	Cant.	UdM	RC1006A0		20	PZ																								
Código	Descripción	Cant.	UdM																																		
RC1006A0		20	PZ																																		
RC1243A			RC1243A0																																		
VL1014A	REDUCTOR DE PRESION CON DISTRIBUIDOR		KVL1014A	KIT REDUCTOR DE PRESION	<table border="1"> <thead> <tr> <th>Código</th> <th>Descripción</th> <th>Cant.</th> <th>UdM</th> </tr> </thead> <tbody> <tr> <td>EL1185A0</td> <td>RACOR CODO J.GUEST Ø8 - Ø8</td> <td>1</td> <td>PZ</td> </tr> <tr> <td>EL1185B0</td> <td>CONEXION A CODO JG Ø8F-Ø8F</td> <td>1</td> <td>PZ</td> </tr> <tr> <td>RC1003A0</td> <td>CONEXION 8M-1/8 BSPP</td> <td>2</td> <td>PZ</td> </tr> <tr> <td>RC1372A0</td> <td>CONEXION RECTA Ø10M-1/4 M CI</td> <td>1</td> <td>PZ</td> </tr> <tr> <td>VL1014A0</td> <td>REDUCTOR DE PRESION CON DISTRIBUIDOR</td> <td>1</td> <td>PZ</td> </tr> <tr> <td>VM2028A0</td> <td>RONDANA GOMA 20X10X</td> <td>1</td> <td>PZ</td> </tr> <tr> <td>VM2059A0</td> <td>TAPON 1/4" CIL CON O-RIN</td> <td>1</td> <td>PZ</td> </tr> </tbody> </table>	Código	Descripción	Cant.	UdM	EL1185A0	RACOR CODO J.GUEST Ø8 - Ø8	1	PZ	EL1185B0	CONEXION A CODO JG Ø8F-Ø8F	1	PZ	RC1003A0	CONEXION 8M-1/8 BSPP	2	PZ	RC1372A0	CONEXION RECTA Ø10M-1/4 M CI	1	PZ	VL1014A0	REDUCTOR DE PRESION CON DISTRIBUIDOR	1	PZ	VM2028A0	RONDANA GOMA 20X10X	1	PZ	VM2059A0	TAPON 1/4" CIL CON O-RIN	1	PZ
Código	Descripción	Cant.	UdM																																		
EL1185A0	RACOR CODO J.GUEST Ø8 - Ø8	1	PZ																																		
EL1185B0	CONEXION A CODO JG Ø8F-Ø8F	1	PZ																																		
RC1003A0	CONEXION 8M-1/8 BSPP	2	PZ																																		
RC1372A0	CONEXION RECTA Ø10M-1/4 M CI	1	PZ																																		
VL1014A0	REDUCTOR DE PRESION CON DISTRIBUIDOR	1	PZ																																		
VM2028A0	RONDANA GOMA 20X10X	1	PZ																																		
VM2059A0	TAPON 1/4" CIL CON O-RIN	1	PZ																																		
			KVL0014A	KIT REDUCTOR DE PRESION MIND.MAP	<table border="1"> <thead> <tr> <th>Código</th> <th>Descripción</th> <th>Cant.</th> <th>UdM</th> </tr> </thead> <tbody> <tr> <td>RC1372A0</td> <td>CONEXION RECTA Ø10M-1/4 M CI</td> <td>2</td> <td>PZ</td> </tr> <tr> <td>VL1014A0</td> <td>REDUCTOR DE PRESION CON DISTRIBUIDOR</td> <td>1</td> <td>PZ</td> </tr> <tr> <td>VM1053A0</td> <td></td> <td>2</td> <td>PZ</td> </tr> <tr> <td>VM1054A0</td> <td></td> <td>1</td> <td>PZ</td> </tr> </tbody> </table>	Código	Descripción	Cant.	UdM	RC1372A0	CONEXION RECTA Ø10M-1/4 M CI	2	PZ	VL1014A0	REDUCTOR DE PRESION CON DISTRIBUIDOR	1	PZ	VM1053A0		2	PZ	VM1054A0		1	PZ												
Código	Descripción	Cant.	UdM																																		
RC1372A0	CONEXION RECTA Ø10M-1/4 M CI	2	PZ																																		
VL1014A0	REDUCTOR DE PRESION CON DISTRIBUIDOR	1	PZ																																		
VM1053A0		2	PZ																																		
VM1054A0		1	PZ																																		



COMPONENTE			REPUESTO																		
Código	Descripción	Imagen	Código	Descripción	Lista de componentes																
RC1372A	CONEXION RECTA Ø10M-1/4 M CIL		RC1372A0	CONEXION RECTA Ø10M-1/4 M CIL																	
VM1054A			KVM1054A		<table border="1"> <thead> <tr> <th>Código</th> <th>Descripción</th> <th>Cant.</th> <th>UdM</th> </tr> </thead> <tbody> <tr> <td>VM1054A0</td> <td></td> <td>1</td> <td>PZ</td> </tr> </tbody> </table>	Código	Descripción	Cant.	UdM	VM1054A0		1	PZ								
Código	Descripción	Cant.	UdM																		
VM1054A0		1	PZ																		
RC1004A			KRC1004A		<table border="1"> <thead> <tr> <th>Código</th> <th>Descripción</th> <th>Cant.</th> <th>UdM</th> </tr> </thead> <tbody> <tr> <td>RC1004A0</td> <td></td> <td>10</td> <td>PZ</td> </tr> </tbody> </table>	Código	Descripción	Cant.	UdM	RC1004A0		10	PZ								
Código	Descripción	Cant.	UdM																		
RC1004A0		10	PZ																		
VL1034C			KVL1034C	KIT FILTRO AGUA Ø10 MESH100	<table border="1"> <thead> <tr> <th>Código</th> <th>Descripción</th> <th>Cant.</th> <th>UdM</th> </tr> </thead> <tbody> <tr> <td>RC1002A0</td> <td></td> <td>2</td> <td>PZ</td> </tr> <tr> <td>VL1034C0</td> <td></td> <td>1</td> <td>PZ</td> </tr> <tr> <td>VL1062C0</td> <td></td> <td>1</td> <td>PZ</td> </tr> </tbody> </table>	Código	Descripción	Cant.	UdM	RC1002A0		2	PZ	VL1034C0		1	PZ	VL1062C0		1	PZ
Código	Descripción	Cant.	UdM																		
RC1002A0		2	PZ																		
VL1034C0		1	PZ																		
VL1062C0		1	PZ																		
VL1062C			KVL1034B	KIT RECAMBIO FILTRO AGUA Ø8 Y Ø10	<table border="1"> <thead> <tr> <th>Código</th> <th>Descripción</th> <th>Cant.</th> <th>UdM</th> </tr> </thead> <tbody> <tr> <td>RC1002A0</td> <td></td> <td>2</td> <td>PZ</td> </tr> <tr> <td>VL1034B0</td> <td></td> <td>1</td> <td>PZ</td> </tr> <tr> <td>VL1062C0</td> <td></td> <td>1</td> <td>PZ</td> </tr> </tbody> </table>	Código	Descripción	Cant.	UdM	RC1002A0		2	PZ	VL1034B0		1	PZ	VL1062C0		1	PZ
Código	Descripción	Cant.	UdM																		
RC1002A0		2	PZ																		
VL1034B0		1	PZ																		
VL1062C0		1	PZ																		

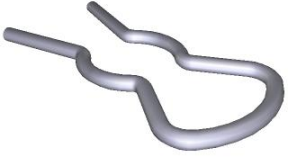

COMPONENTE			REPUESTO																																																																										
Código	Descripción	Imagen	Código	Descripción	Lista de componentes																																																																								
EL1185A	RACOR CODO J.GUEST Ø8 - Ø8		KEL1185B	KIT 10 UDS CONEXION CODO Ø8F-Ø8F	<table border="1"> <thead> <tr> <th>Código</th> <th>Descripción</th> <th>Cant.</th> <th>UdM</th> </tr> </thead> <tbody> <tr> <td>EL1185B0</td> <td>CONEXION A CODO JG Ø8F-Ø8F</td> <td>10</td> <td>PZ</td> </tr> </tbody> </table>	Código	Descripción	Cant.	UdM	EL1185B0	CONEXION A CODO JG Ø8F-Ø8F	10	PZ																																																																
			Código	Descripción	Cant.	UdM																																																																							
EL1185B0	CONEXION A CODO JG Ø8F-Ø8F	10	PZ																																																																										
KEL1185A	KIT 10 UDS CONEXION A CODO Ø8F-Ø8F	<table border="1"> <thead> <tr> <th>Código</th> <th>Descripción</th> <th>Cant.</th> <th>UdM</th> </tr> </thead> <tbody> <tr> <td>EL1185A0</td> <td>RACOR CODO J.GUEST Ø8 - Ø8</td> <td>10</td> <td>PZ</td> </tr> </tbody> </table>	Código	Descripción	Cant.	UdM	EL1185A0	RACOR CODO J.GUEST Ø8 - Ø8	10	PZ																																																																			
Código	Descripción	Cant.	UdM																																																																										
EL1185A0	RACOR CODO J.GUEST Ø8 - Ø8	10	PZ																																																																										
VM1066A			VM1066A0																																																																										
GN1312A			KVL0001A	KIT CIRCUITO SISTEMA LAVADO LM TOP	<table border="1"> <thead> <tr> <th>Código</th> <th>Descripción</th> <th>Cant.</th> <th>UdM</th> </tr> </thead> <tbody> <tr> <td>0H1226A0</td> <td>PANEL CIRCUITO DE LIMPIADO LINE MISS</td> <td>1</td> <td>PZ</td> </tr> <tr> <td>0H1226B0</td> <td>PANEL CIRCUITO DE LIMPIADO LINE MISS</td> <td>1</td> <td>PZ</td> </tr> <tr> <td>EL1180A0</td> <td>CONEXION DE RETENCION Ø8 Ø8 HEMBR</td> <td>1</td> <td>PZ</td> </tr> <tr> <td>GN1312A0</td> <td></td> <td>1</td> <td>PZ</td> </tr> <tr> <td>GN1526A0</td> <td></td> <td>1</td> <td>PZ</td> </tr> <tr> <td>RC1008A0</td> <td></td> <td>3</td> <td>PZ</td> </tr> <tr> <td>RC1019A0</td> <td></td> <td>3</td> <td>PZ</td> </tr> <tr> <td>RC1242A0</td> <td></td> <td>2</td> <td>PZ</td> </tr> <tr> <td>RC1381A0</td> <td></td> <td>3</td> <td>PZ</td> </tr> <tr> <td>TB2343A0</td> <td>TUBO TRANSPAREN TE PVC 9X6</td> <td>2.630</td> <td>M</td> </tr> <tr> <td>TB2820A0</td> <td>TUBO EPDM 6X10</td> <td>0.990</td> <td>M</td> </tr> <tr> <td>VI1220A1</td> <td>VITE AUTOFIL. 4.2X12 TCB MARUTEX</td> <td>1</td> <td>PZ</td> </tr> <tr> <td>VL1019A0</td> <td></td> <td>1</td> <td>PZ</td> </tr> <tr> <td>VL1041C0</td> <td>TAPON DETERGENTE PERFORADO Ø12</td> <td>1</td> <td>PZ</td> </tr> <tr> <td>VL1047A1</td> <td>SOPORTE TUBO D6 - D8 EXTREMO J.G.</td> <td>1</td> <td>PZ</td> </tr> <tr> <td>VL1053A1</td> <td></td> <td>1</td> <td>PZ</td> </tr> <tr> <td>VL1053B0</td> <td></td> <td>1</td> <td>PZ</td> </tr> </tbody> </table>	Código	Descripción	Cant.	UdM	0H1226A0	PANEL CIRCUITO DE LIMPIADO LINE MISS	1	PZ	0H1226B0	PANEL CIRCUITO DE LIMPIADO LINE MISS	1	PZ	EL1180A0	CONEXION DE RETENCION Ø8 Ø8 HEMBR	1	PZ	GN1312A0		1	PZ	GN1526A0		1	PZ	RC1008A0		3	PZ	RC1019A0		3	PZ	RC1242A0		2	PZ	RC1381A0		3	PZ	TB2343A0	TUBO TRANSPAREN TE PVC 9X6	2.630	M	TB2820A0	TUBO EPDM 6X10	0.990	M	VI1220A1	VITE AUTOFIL. 4.2X12 TCB MARUTEX	1	PZ	VL1019A0		1	PZ	VL1041C0	TAPON DETERGENTE PERFORADO Ø12	1	PZ	VL1047A1	SOPORTE TUBO D6 - D8 EXTREMO J.G.	1	PZ	VL1053A1		1	PZ	VL1053B0		1	PZ
Código	Descripción	Cant.	UdM																																																																										
0H1226A0	PANEL CIRCUITO DE LIMPIADO LINE MISS	1	PZ																																																																										
0H1226B0	PANEL CIRCUITO DE LIMPIADO LINE MISS	1	PZ																																																																										
EL1180A0	CONEXION DE RETENCION Ø8 Ø8 HEMBR	1	PZ																																																																										
GN1312A0		1	PZ																																																																										
GN1526A0		1	PZ																																																																										
RC1008A0		3	PZ																																																																										
RC1019A0		3	PZ																																																																										
RC1242A0		2	PZ																																																																										
RC1381A0		3	PZ																																																																										
TB2343A0	TUBO TRANSPAREN TE PVC 9X6	2.630	M																																																																										
TB2820A0	TUBO EPDM 6X10	0.990	M																																																																										
VI1220A1	VITE AUTOFIL. 4.2X12 TCB MARUTEX	1	PZ																																																																										
VL1019A0		1	PZ																																																																										
VL1041C0	TAPON DETERGENTE PERFORADO Ø12	1	PZ																																																																										
VL1047A1	SOPORTE TUBO D6 - D8 EXTREMO J.G.	1	PZ																																																																										
VL1053A1		1	PZ																																																																										
VL1053B0		1	PZ																																																																										

COMPONENTE			REPUESTO																																																																																										
Código	Descripción	Imagen	Código	Descripción	Lista de componentes																																																																																								
GN1312A			KVL0001A	KIT CIRCUITO SISTEMA LAVADO LM TOP	<table border="1"> <thead> <tr> <th>Código</th> <th>Descripción</th> <th>Cant.</th> <th>UdM</th> </tr> </thead> <tbody> <tr> <td>VL1054A1</td> <td></td> <td>1</td> <td>PZ</td> </tr> <tr> <td>VL1054B0</td> <td></td> <td>1</td> <td>PZ</td> </tr> <tr> <td>VL1061A0</td> <td></td> <td>1</td> <td>PZ</td> </tr> <tr> <td>VL1081A0</td> <td></td> <td>1</td> <td>PZ</td> </tr> <tr> <td>VM1066A0</td> <td></td> <td>3</td> <td>PZ</td> </tr> <tr> <td>VM1088A0</td> <td></td> <td>1</td> <td>PZ</td> </tr> <tr> <td>VM1605A0</td> <td></td> <td>1</td> <td>PZ</td> </tr> <tr> <td>VM2172A0</td> <td></td> <td>1</td> <td>PZ</td> </tr> </tbody> </table>	Código	Descripción	Cant.	UdM	VL1054A1		1	PZ	VL1054B0		1	PZ	VL1061A0		1	PZ	VL1081A0		1	PZ	VM1066A0		3	PZ	VM1088A0		1	PZ	VM1605A0		1	PZ	VM2172A0		1	PZ																																																				
Código	Descripción	Cant.	UdM																																																																																										
VL1054A1		1	PZ																																																																																										
VL1054B0		1	PZ																																																																																										
VL1061A0		1	PZ																																																																																										
VL1081A0		1	PZ																																																																																										
VM1066A0		3	PZ																																																																																										
VM1088A0		1	PZ																																																																																										
VM1605A0		1	PZ																																																																																										
VM2172A0		1	PZ																																																																																										
VL1061A			KVL1061A		<table border="1"> <thead> <tr> <th>Código</th> <th>Descripción</th> <th>Cant.</th> <th>UdM</th> </tr> </thead> <tbody> <tr> <td>VL1061A0</td> <td></td> <td>1</td> <td>PZ</td> </tr> <tr> <td>VM1088A0</td> <td></td> <td>1</td> <td>PZ</td> </tr> </tbody> </table>	Código	Descripción	Cant.	UdM	VL1061A0		1	PZ	VM1088A0		1	PZ																																																																												
Código	Descripción	Cant.	UdM																																																																																										
VL1061A0		1	PZ																																																																																										
VM1088A0		1	PZ																																																																																										
VM1088A			KVM1088A		<table border="1"> <thead> <tr> <th>Código</th> <th>Descripción</th> <th>Cant.</th> <th>UdM</th> </tr> </thead> <tbody> <tr> <td>VM1088A0</td> <td></td> <td>5</td> <td>PZ</td> </tr> </tbody> </table>	Código	Descripción	Cant.	UdM	VM1088A0		5	PZ																																																																																
Código	Descripción	Cant.	UdM																																																																																										
VM1088A0		5	PZ																																																																																										
VL1019A			KVL1101A	KIT SISTEMA LAVADO PLUS EU	<table border="1"> <thead> <tr> <th>Código</th> <th>Descripción</th> <th>Cant.</th> <th>UdM</th> </tr> </thead> <tbody> <tr> <td>0H7323A0</td> <td></td> <td>1</td> <td>PZ</td> </tr> <tr> <td>EL1252A1</td> <td>ELECTROVAL VULA 1 VIA + CONEXION J.G</td> <td>1</td> <td>PZ</td> </tr> <tr> <td>EL1424A0</td> <td></td> <td>1</td> <td>PZ</td> </tr> <tr> <td>EL1436A0</td> <td></td> <td>1</td> <td>PZ</td> </tr> <tr> <td>GN1526A0</td> <td></td> <td>1</td> <td>PZ</td> </tr> <tr> <td>RC1019A0</td> <td></td> <td>11</td> <td>PZ</td> </tr> <tr> <td>RC1130A0</td> <td></td> <td>1</td> <td>PZ</td> </tr> <tr> <td>RC1242A0</td> <td></td> <td>2</td> <td>PZ</td> </tr> <tr> <td>RC1310A0</td> <td></td> <td>2</td> <td>PZ</td> </tr> <tr> <td>RC1356A0</td> <td></td> <td>1</td> <td>PZ</td> </tr> <tr> <td>TB1818A0</td> <td></td> <td>0.220</td> <td>M</td> </tr> <tr> <td>TB2820A0</td> <td>TUBO EPDM 6X10</td> <td>1.240</td> <td>M</td> </tr> <tr> <td>VI1220A1</td> <td>VITE AUTOFIL. 4.2X12 TCB MARUTEX</td> <td>2</td> <td>PZ</td> </tr> <tr> <td>VL1019A0</td> <td></td> <td>1</td> <td>PZ</td> </tr> <tr> <td>VL1064A0</td> <td></td> <td>1</td> <td>PZ</td> </tr> <tr> <td>VL1065A1</td> <td></td> <td>1</td> <td>PZ</td> </tr> <tr> <td>VL1067A0</td> <td></td> <td>1</td> <td>PZ</td> </tr> <tr> <td>VL1080A0</td> <td></td> <td>1</td> <td>PZ</td> </tr> <tr> <td>VL1081A0</td> <td></td> <td>2</td> <td>PZ</td> </tr> <tr> <td>VL1083A0</td> <td></td> <td>1</td> <td>PZ</td> </tr> <tr> <td>VM2172A0</td> <td></td> <td>1</td> <td>PZ</td> </tr> </tbody> </table>	Código	Descripción	Cant.	UdM	0H7323A0		1	PZ	EL1252A1	ELECTROVAL VULA 1 VIA + CONEXION J.G	1	PZ	EL1424A0		1	PZ	EL1436A0		1	PZ	GN1526A0		1	PZ	RC1019A0		11	PZ	RC1130A0		1	PZ	RC1242A0		2	PZ	RC1310A0		2	PZ	RC1356A0		1	PZ	TB1818A0		0.220	M	TB2820A0	TUBO EPDM 6X10	1.240	M	VI1220A1	VITE AUTOFIL. 4.2X12 TCB MARUTEX	2	PZ	VL1019A0		1	PZ	VL1064A0		1	PZ	VL1065A1		1	PZ	VL1067A0		1	PZ	VL1080A0		1	PZ	VL1081A0		2	PZ	VL1083A0		1	PZ	VM2172A0		1	PZ
Código	Descripción	Cant.	UdM																																																																																										
0H7323A0		1	PZ																																																																																										
EL1252A1	ELECTROVAL VULA 1 VIA + CONEXION J.G	1	PZ																																																																																										
EL1424A0		1	PZ																																																																																										
EL1436A0		1	PZ																																																																																										
GN1526A0		1	PZ																																																																																										
RC1019A0		11	PZ																																																																																										
RC1130A0		1	PZ																																																																																										
RC1242A0		2	PZ																																																																																										
RC1310A0		2	PZ																																																																																										
RC1356A0		1	PZ																																																																																										
TB1818A0		0.220	M																																																																																										
TB2820A0	TUBO EPDM 6X10	1.240	M																																																																																										
VI1220A1	VITE AUTOFIL. 4.2X12 TCB MARUTEX	2	PZ																																																																																										
VL1019A0		1	PZ																																																																																										
VL1064A0		1	PZ																																																																																										
VL1065A1		1	PZ																																																																																										
VL1067A0		1	PZ																																																																																										
VL1080A0		1	PZ																																																																																										
VL1081A0		2	PZ																																																																																										
VL1083A0		1	PZ																																																																																										
VM2172A0		1	PZ																																																																																										

COMPONENTE			REPUESTO																																																							
Código	Descripción	Imagen	Código	Descripción	Lista de componentes																																																					
VL1019A			KVL1073A	KIT BOMBA LAVADO MIND.MAPS PLUS	<table border="1"> <thead> <tr> <th>Código</th> <th>Descripción</th> <th>Cant.</th> <th>UdM</th> </tr> </thead> <tbody> <tr><td>GN1526A0</td><td></td><td>1</td><td>PZ</td></tr> <tr><td>RC1019A0</td><td></td><td>4</td><td>PZ</td></tr> <tr><td>RC1130A0</td><td></td><td>1</td><td>PZ</td></tr> <tr><td>RC1242A0</td><td></td><td>2</td><td>PZ</td></tr> <tr><td>TB2820A0</td><td>TUBO EPDM 6X10</td><td>0.120</td><td>M</td></tr> <tr><td>VL1019A0</td><td></td><td>1</td><td>PZ</td></tr> <tr><td>VL1064A0</td><td></td><td>1</td><td>PZ</td></tr> <tr><td>VL1067A0</td><td></td><td>1</td><td>PZ</td></tr> <tr><td>VL1081A0</td><td></td><td>1</td><td>PZ</td></tr> <tr><td>VM2172A0</td><td></td><td>1</td><td>PZ</td></tr> </tbody> </table>	Código	Descripción	Cant.	UdM	GN1526A0		1	PZ	RC1019A0		4	PZ	RC1130A0		1	PZ	RC1242A0		2	PZ	TB2820A0	TUBO EPDM 6X10	0.120	M	VL1019A0		1	PZ	VL1064A0		1	PZ	VL1067A0		1	PZ	VL1081A0		1	PZ	VM2172A0		1	PZ									
			Código	Descripción	Cant.	UdM																																																				
			GN1526A0		1	PZ																																																				
RC1019A0		4	PZ																																																							
RC1130A0		1	PZ																																																							
RC1242A0		2	PZ																																																							
TB2820A0	TUBO EPDM 6X10	0.120	M																																																							
VL1019A0		1	PZ																																																							
VL1064A0		1	PZ																																																							
VL1067A0		1	PZ																																																							
VL1081A0		1	PZ																																																							
VM2172A0		1	PZ																																																							
KVL1072A	KIT BOMBA LAVADO MIND.MAPS ONE	<table border="1"> <thead> <tr> <th>Código</th> <th>Descripción</th> <th>Cant.</th> <th>UdM</th> </tr> </thead> <tbody> <tr><td>GN1526A0</td><td></td><td>1</td><td>PZ</td></tr> <tr><td>RC1019A0</td><td></td><td>3</td><td>PZ</td></tr> <tr><td>RC1242A0</td><td></td><td>2</td><td>PZ</td></tr> <tr><td>TB2820A0</td><td>TUBO EPDM 6X10</td><td>0.120</td><td>M</td></tr> <tr><td>VI1220A1</td><td>VITE AUTOFIL. 4.2X12 TCB MARUTEX</td><td>1</td><td>PZ</td></tr> <tr><td>VL1019A0</td><td></td><td>1</td><td>PZ</td></tr> <tr><td>VL1053B0</td><td></td><td>1</td><td>PZ</td></tr> <tr><td>VL1054B0</td><td></td><td>1</td><td>PZ</td></tr> <tr><td>VL1081A0</td><td></td><td>2</td><td>PZ</td></tr> <tr><td>VM2172A0</td><td></td><td>1</td><td>PZ</td></tr> </tbody> </table>	Código	Descripción	Cant.	UdM	GN1526A0		1	PZ	RC1019A0		3	PZ	RC1242A0		2	PZ	TB2820A0	TUBO EPDM 6X10	0.120	M	VI1220A1	VITE AUTOFIL. 4.2X12 TCB MARUTEX	1	PZ	VL1019A0		1	PZ	VL1053B0		1	PZ	VL1054B0		1	PZ	VL1081A0		2	PZ	VM2172A0		1	PZ												
Código	Descripción	Cant.	UdM																																																							
GN1526A0		1	PZ																																																							
RC1019A0		3	PZ																																																							
RC1242A0		2	PZ																																																							
TB2820A0	TUBO EPDM 6X10	0.120	M																																																							
VI1220A1	VITE AUTOFIL. 4.2X12 TCB MARUTEX	1	PZ																																																							
VL1019A0		1	PZ																																																							
VL1053B0		1	PZ																																																							
VL1054B0		1	PZ																																																							
VL1081A0		2	PZ																																																							
VM2172A0		1	PZ																																																							
KVL0001A	KIT CIRCUITO SISTEMA LAVADO LM TOP	<table border="1"> <thead> <tr> <th>Código</th> <th>Descripción</th> <th>Cant.</th> <th>UdM</th> </tr> </thead> <tbody> <tr><td>0H1226A0</td><td>PANEL CIRCUITO DE LIMPIADO LINE MISS</td><td>1</td><td>PZ</td></tr> <tr><td>0H1226B0</td><td>PANEL CIRCUITO DE LIMPIADO LINE MISS</td><td>1</td><td>PZ</td></tr> <tr><td>EL1180A0</td><td>CONEXION DE RETENCION Ø8 Ø8 HEMBR</td><td>1</td><td>PZ</td></tr> <tr><td>GN1312A0</td><td></td><td>1</td><td>PZ</td></tr> <tr><td>GN1526A0</td><td></td><td>1</td><td>PZ</td></tr> <tr><td>RC1008A0</td><td></td><td>3</td><td>PZ</td></tr> <tr><td>RC1019A0</td><td></td><td>3</td><td>PZ</td></tr> <tr><td>RC1242A0</td><td></td><td>2</td><td>PZ</td></tr> <tr><td>RC1381A0</td><td></td><td>3</td><td>PZ</td></tr> <tr><td>TB2343A0</td><td>TUBO TRANSPAREN TE PVC 9X6</td><td>2.630</td><td>M</td></tr> <tr><td>TB2820A0</td><td>TUBO EPDM 6X10</td><td>0.990</td><td>M</td></tr> <tr><td>VI1220A1</td><td>VITE AUTOFIL. 4.2X12 TCB MARUTEX</td><td>1</td><td>PZ</td></tr> <tr><td>VL1019A0</td><td></td><td>1</td><td>PZ</td></tr> </tbody> </table>	Código	Descripción	Cant.	UdM	0H1226A0	PANEL CIRCUITO DE LIMPIADO LINE MISS	1	PZ	0H1226B0	PANEL CIRCUITO DE LIMPIADO LINE MISS	1	PZ	EL1180A0	CONEXION DE RETENCION Ø8 Ø8 HEMBR	1	PZ	GN1312A0		1	PZ	GN1526A0		1	PZ	RC1008A0		3	PZ	RC1019A0		3	PZ	RC1242A0		2	PZ	RC1381A0		3	PZ	TB2343A0	TUBO TRANSPAREN TE PVC 9X6	2.630	M	TB2820A0	TUBO EPDM 6X10	0.990	M	VI1220A1	VITE AUTOFIL. 4.2X12 TCB MARUTEX	1	PZ	VL1019A0		1	PZ
Código	Descripción	Cant.	UdM																																																							
0H1226A0	PANEL CIRCUITO DE LIMPIADO LINE MISS	1	PZ																																																							
0H1226B0	PANEL CIRCUITO DE LIMPIADO LINE MISS	1	PZ																																																							
EL1180A0	CONEXION DE RETENCION Ø8 Ø8 HEMBR	1	PZ																																																							
GN1312A0		1	PZ																																																							
GN1526A0		1	PZ																																																							
RC1008A0		3	PZ																																																							
RC1019A0		3	PZ																																																							
RC1242A0		2	PZ																																																							
RC1381A0		3	PZ																																																							
TB2343A0	TUBO TRANSPAREN TE PVC 9X6	2.630	M																																																							
TB2820A0	TUBO EPDM 6X10	0.990	M																																																							
VI1220A1	VITE AUTOFIL. 4.2X12 TCB MARUTEX	1	PZ																																																							
VL1019A0		1	PZ																																																							

COMPONENTE			REPUESTO																																																						
Código	Descripción	Imagen	Código	Descripción	Lista de componentes																																																				
VL1019A			KVL0001A	KIT CIRCUITO SISTEMA LAVADO LM TOP	<table border="1"> <thead> <tr> <th>Código</th> <th>Descripción</th> <th>Cant.</th> <th>UdM</th> </tr> </thead> <tbody> <tr> <td>VL1041C0</td> <td>TAPON DETERGENTE PERFORADO Ø12</td> <td>1</td> <td>PZ</td> </tr> <tr> <td>VL1047A1</td> <td>SOPORTE TUBO D6 - D8 EXTREMO J.G.</td> <td>1</td> <td>PZ</td> </tr> <tr> <td>VL1053A1</td> <td></td> <td>1</td> <td>PZ</td> </tr> <tr> <td>VL1053B0</td> <td></td> <td>1</td> <td>PZ</td> </tr> <tr> <td>VL1054A1</td> <td></td> <td>1</td> <td>PZ</td> </tr> <tr> <td>VL1054B0</td> <td></td> <td>1</td> <td>PZ</td> </tr> <tr> <td>VL1061A0</td> <td></td> <td>1</td> <td>PZ</td> </tr> <tr> <td>VL1081A0</td> <td></td> <td>1</td> <td>PZ</td> </tr> <tr> <td>VM1066A0</td> <td></td> <td>3</td> <td>PZ</td> </tr> <tr> <td>VM1088A0</td> <td></td> <td>1</td> <td>PZ</td> </tr> <tr> <td>VM1605A0</td> <td></td> <td>1</td> <td>PZ</td> </tr> <tr> <td>VM2172A0</td> <td></td> <td>1</td> <td>PZ</td> </tr> </tbody> </table>	Código	Descripción	Cant.	UdM	VL1041C0	TAPON DETERGENTE PERFORADO Ø12	1	PZ	VL1047A1	SOPORTE TUBO D6 - D8 EXTREMO J.G.	1	PZ	VL1053A1		1	PZ	VL1053B0		1	PZ	VL1054A1		1	PZ	VL1054B0		1	PZ	VL1061A0		1	PZ	VL1081A0		1	PZ	VM1066A0		3	PZ	VM1088A0		1	PZ	VM1605A0		1	PZ	VM2172A0		1	PZ
Código	Descripción	Cant.	UdM																																																						
VL1041C0	TAPON DETERGENTE PERFORADO Ø12	1	PZ																																																						
VL1047A1	SOPORTE TUBO D6 - D8 EXTREMO J.G.	1	PZ																																																						
VL1053A1		1	PZ																																																						
VL1053B0		1	PZ																																																						
VL1054A1		1	PZ																																																						
VL1054B0		1	PZ																																																						
VL1061A0		1	PZ																																																						
VL1081A0		1	PZ																																																						
VM1066A0		3	PZ																																																						
VM1088A0		1	PZ																																																						
VM1605A0		1	PZ																																																						
VM2172A0		1	PZ																																																						
VM2172A			VM2172A0																																																						
RC1019A			KRC1019A	KIT 5 UDS CLIP ELASTICA DE CINC Ø10	<table border="1"> <thead> <tr> <th>Código</th> <th>Descripción</th> <th>Cant.</th> <th>UdM</th> </tr> </thead> <tbody> <tr> <td>RC1019A0</td> <td></td> <td>15</td> <td>PZ</td> </tr> </tbody> </table>	Código	Descripción	Cant.	UdM	RC1019A0		15	PZ																																												
Código	Descripción	Cant.	UdM																																																						
RC1019A0		15	PZ																																																						
VL1081A			KVL1081A		<table border="1"> <thead> <tr> <th>Código</th> <th>Descripción</th> <th>Cant.</th> <th>UdM</th> </tr> </thead> <tbody> <tr> <td>TB2820A0</td> <td>TUBO EPDM 6X10</td> <td>0.240</td> <td>M</td> </tr> <tr> <td>VL1081A0</td> <td></td> <td>3</td> <td>PZ</td> </tr> </tbody> </table>	Código	Descripción	Cant.	UdM	TB2820A0	TUBO EPDM 6X10	0.240	M	VL1081A0		3	PZ																																								
Código	Descripción	Cant.	UdM																																																						
TB2820A0	TUBO EPDM 6X10	0.240	M																																																						
VL1081A0		3	PZ																																																						

COMPONENTE			REPUESTO																																																																																																										
Código	Descripción	Imagen	Código	Descripción	Lista de componentes																																																																																																								
RC1242A			RC1242A0																																																																																																										
VL1054B			KVL0001A	KIT CIRCUITO SISTEMA LAVADO LM TOP	<table border="1"> <thead> <tr> <th>Código</th> <th>Descripción</th> <th>Cant.</th> <th>UdM</th> </tr> </thead> <tbody> <tr> <td>0H1226A0</td> <td>PANEL CIRCUITO DE LIMPIADO LINE MISS</td> <td>1</td> <td>PZ</td> </tr> <tr> <td>0H1226B0</td> <td>PANEL CIRCUITO DE LIMPIADO LINE MISS</td> <td>1</td> <td>PZ</td> </tr> <tr> <td>EL1180A0</td> <td>CONEXION DE RETENCION Ø8 Ø8 HEMBR</td> <td>1</td> <td>PZ</td> </tr> <tr> <td>GN1312A0</td> <td></td> <td>1</td> <td>PZ</td> </tr> <tr> <td>GN1526A0</td> <td></td> <td>1</td> <td>PZ</td> </tr> <tr> <td>RC1008A0</td> <td></td> <td>3</td> <td>PZ</td> </tr> <tr> <td>RC1019A0</td> <td></td> <td>3</td> <td>PZ</td> </tr> <tr> <td>RC1242A0</td> <td></td> <td>2</td> <td>PZ</td> </tr> <tr> <td>RC1381A0</td> <td></td> <td>3</td> <td>PZ</td> </tr> <tr> <td>TB2343A0</td> <td>TUBO TRANSPAREN TE PVC 9X6</td> <td>2.630</td> <td>M</td> </tr> <tr> <td>TB2820A0</td> <td>TUBO EPDM 6X10</td> <td>0.990</td> <td>M</td> </tr> <tr> <td>VH1220A1</td> <td>VITE AUTOFIL. 4.2X12 TCB MARUTEX</td> <td>1</td> <td>PZ</td> </tr> <tr> <td>VL1019A0</td> <td></td> <td>1</td> <td>PZ</td> </tr> <tr> <td>VL1041C0</td> <td>TAPON DETERGENTE PERFORADO Ø12</td> <td>1</td> <td>PZ</td> </tr> <tr> <td>VL1047A1</td> <td>SOPORTE TUBO D6 - D8 EXTREMO J.G.</td> <td>1</td> <td>PZ</td> </tr> <tr> <td>VL1053A1</td> <td></td> <td>1</td> <td>PZ</td> </tr> <tr> <td>VL1053B0</td> <td></td> <td>1</td> <td>PZ</td> </tr> <tr> <td>VL1054A1</td> <td></td> <td>1</td> <td>PZ</td> </tr> <tr> <td>VL1054B0</td> <td></td> <td>1</td> <td>PZ</td> </tr> <tr> <td>VL1061A0</td> <td></td> <td>1</td> <td>PZ</td> </tr> <tr> <td>VL1081A0</td> <td></td> <td>1</td> <td>PZ</td> </tr> <tr> <td>VM1066A0</td> <td></td> <td>3</td> <td>PZ</td> </tr> <tr> <td>VM1088A0</td> <td></td> <td>1</td> <td>PZ</td> </tr> <tr> <td>VM1605A0</td> <td></td> <td>1</td> <td>PZ</td> </tr> <tr> <td>VM2172A0</td> <td></td> <td>1</td> <td>PZ</td> </tr> </tbody> </table>	Código	Descripción	Cant.	UdM	0H1226A0	PANEL CIRCUITO DE LIMPIADO LINE MISS	1	PZ	0H1226B0	PANEL CIRCUITO DE LIMPIADO LINE MISS	1	PZ	EL1180A0	CONEXION DE RETENCION Ø8 Ø8 HEMBR	1	PZ	GN1312A0		1	PZ	GN1526A0		1	PZ	RC1008A0		3	PZ	RC1019A0		3	PZ	RC1242A0		2	PZ	RC1381A0		3	PZ	TB2343A0	TUBO TRANSPAREN TE PVC 9X6	2.630	M	TB2820A0	TUBO EPDM 6X10	0.990	M	VH1220A1	VITE AUTOFIL. 4.2X12 TCB MARUTEX	1	PZ	VL1019A0		1	PZ	VL1041C0	TAPON DETERGENTE PERFORADO Ø12	1	PZ	VL1047A1	SOPORTE TUBO D6 - D8 EXTREMO J.G.	1	PZ	VL1053A1		1	PZ	VL1053B0		1	PZ	VL1054A1		1	PZ	VL1054B0		1	PZ	VL1061A0		1	PZ	VL1081A0		1	PZ	VM1066A0		3	PZ	VM1088A0		1	PZ	VM1605A0		1	PZ	VM2172A0		1	PZ
Código	Descripción	Cant.	UdM																																																																																																										
0H1226A0	PANEL CIRCUITO DE LIMPIADO LINE MISS	1	PZ																																																																																																										
0H1226B0	PANEL CIRCUITO DE LIMPIADO LINE MISS	1	PZ																																																																																																										
EL1180A0	CONEXION DE RETENCION Ø8 Ø8 HEMBR	1	PZ																																																																																																										
GN1312A0		1	PZ																																																																																																										
GN1526A0		1	PZ																																																																																																										
RC1008A0		3	PZ																																																																																																										
RC1019A0		3	PZ																																																																																																										
RC1242A0		2	PZ																																																																																																										
RC1381A0		3	PZ																																																																																																										
TB2343A0	TUBO TRANSPAREN TE PVC 9X6	2.630	M																																																																																																										
TB2820A0	TUBO EPDM 6X10	0.990	M																																																																																																										
VH1220A1	VITE AUTOFIL. 4.2X12 TCB MARUTEX	1	PZ																																																																																																										
VL1019A0		1	PZ																																																																																																										
VL1041C0	TAPON DETERGENTE PERFORADO Ø12	1	PZ																																																																																																										
VL1047A1	SOPORTE TUBO D6 - D8 EXTREMO J.G.	1	PZ																																																																																																										
VL1053A1		1	PZ																																																																																																										
VL1053B0		1	PZ																																																																																																										
VL1054A1		1	PZ																																																																																																										
VL1054B0		1	PZ																																																																																																										
VL1061A0		1	PZ																																																																																																										
VL1081A0		1	PZ																																																																																																										
VM1066A0		3	PZ																																																																																																										
VM1088A0		1	PZ																																																																																																										
VM1605A0		1	PZ																																																																																																										
VM2172A0		1	PZ																																																																																																										

COMPONENTE			REPUESTO										
Código	Descripción	Imagen	Código	Descripción	Lista de componentes								
VL1053B			KVL0001A	KIT CIRCUITO SISTEMA LAVADO LM TOP	Código	Descripción	Cant.	UdM					
					0H1226A0	PANEL CIRCUITO DE LIMPIADO LINE MISS	1	PZ					
					0H1226B0	PANEL CIRCUITO DE LIMPIADO LINE MISS	1	PZ					
					EL1180A0	CONEXION DE RETENCION Ø8 Ø8 HEMBR	1	PZ					
					GN1312A0		1	PZ					
					GN1526A0		1	PZ					
					RC1008A0		3	PZ					
					RC1019A0		3	PZ					
					RC1242A0		2	PZ					
					RC1381A0		3	PZ					
					TB2343A0	TUBO TRANSPAREN TE PVC 9X6	2.630	M					
					TB2820A0	TUBO EPDM 6X10	0.990	M					
					VI1220A1	VITE AUTOFIL. 4.2X12 TCB MARUTEX	1	PZ					
					VL1019A0		1	PZ					
					VL1041C0	TAPON DETERGENTE PERFORADO Ø12	1	PZ					
					VL1047A1	SOPORTE TUBO D6 - D8 EXTREMO J.G.	1	PZ					
					VL1053A1		1	PZ					
					VL1053B0		1	PZ					
					VL1054A1		1	PZ					
					VL1054B0		1	PZ					
					VL1061A0		1	PZ					
					VL1081A0		1	PZ					
					VM1066A0		3	PZ					
					VM1088A0		1	PZ					
					VM1605A0		1	PZ					
					VM2172A0		1	PZ					
					EL1436A			KEL1436A	KIT ELECTROVALVULA JG Ø8 CONEXION Ø	Código	Descripción	Cant.	UdM
										EL1436A0		1	PZ



COMPONENTE			REPUESTO																																		
Código	Descripción	Imagen	Código	Descripción	Lista de componentes																																
0H1226B	PANEL CIRCUITO DE LIMPIADO LINE MISS		0H1226B0	PANEL CIRCUITO DE LIMPIADO LINE MISS																																	
VL1041C	TAPON DETERGENTE PERFORADO Ø12		KVL1044B	KIT ALIMENTADOR DE DETERGENTE	<table border="1"> <thead> <tr> <th>Código</th> <th>Descripción</th> <th>Cant.</th> <th>UdM</th> </tr> </thead> <tbody> <tr> <td>EL1348A0</td> <td>CLIP BLOQUEO PINZA CONEXIONES Ø6</td> <td>1</td> <td>PZ</td> </tr> <tr> <td>RC1008A0</td> <td></td> <td>1</td> <td>PZ</td> </tr> <tr> <td>RC1373A0</td> <td>CONEXION CODO Ø6F-Ø6</td> <td>1</td> <td>PZ</td> </tr> <tr> <td>TB2343A0</td> <td>TUBO TRANSPARENTE PVC 9X6</td> <td>2</td> <td>M</td> </tr> <tr> <td>VL1041C0</td> <td>TAPON DETERGENTE PERFORADO Ø12</td> <td>1</td> <td>PZ</td> </tr> <tr> <td>VL1044B0</td> <td>FILTRO ARMADO CON BOYA</td> <td>1</td> <td>PZ</td> </tr> <tr> <td>VL1046A1</td> <td>SOPORTE TUBO D6 - D6 EXTREMO J.G.</td> <td>1</td> <td>PZ</td> </tr> </tbody> </table>	Código	Descripción	Cant.	UdM	EL1348A0	CLIP BLOQUEO PINZA CONEXIONES Ø6	1	PZ	RC1008A0		1	PZ	RC1373A0	CONEXION CODO Ø6F-Ø6	1	PZ	TB2343A0	TUBO TRANSPARENTE PVC 9X6	2	M	VL1041C0	TAPON DETERGENTE PERFORADO Ø12	1	PZ	VL1044B0	FILTRO ARMADO CON BOYA	1	PZ	VL1046A1	SOPORTE TUBO D6 - D6 EXTREMO J.G.	1	PZ
Código	Descripción	Cant.	UdM																																		
EL1348A0	CLIP BLOQUEO PINZA CONEXIONES Ø6	1	PZ																																		
RC1008A0		1	PZ																																		
RC1373A0	CONEXION CODO Ø6F-Ø6	1	PZ																																		
TB2343A0	TUBO TRANSPARENTE PVC 9X6	2	M																																		
VL1041C0	TAPON DETERGENTE PERFORADO Ø12	1	PZ																																		
VL1044B0	FILTRO ARMADO CON BOYA	1	PZ																																		
VL1046A1	SOPORTE TUBO D6 - D6 EXTREMO J.G.	1	PZ																																		